



AQUALISA

A GREAT DAY STARTS
WITH A GREAT SHOWER



A close-up photograph of water splashing onto a white surface, creating a dynamic, textured pattern of droplets and ripples. The water is dark and contrasts sharply with the bright white background.

a better shower

AQUALISA INNOVATION

As pioneers of shower technology, Aqualisa has, over the years, established a reputation for quality and innovation of which it is justifiably proud. We really are perfectionists when it comes to showers and, as a result, the Aqualisa name is trusted by both homeowners and installers alike.

Welcome, therefore, to the latest brochure showcasing our extensive product ranges for smart, mixer, electric and power showers, where quality, performance and reliability come as standard. All our showers focus on safety and control to ensure we can deliver a better, more personal, showering experience for the whole family.

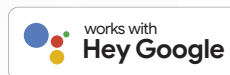

Quartz Touch™ smart shower, page 20



Dream™ concealed thermostatic mixer, page 42

Looks are important too and you will be able to find and select an Aqualisa shower design that expresses your own style aspirations and makes a bold feature statement as part of a new or existing bathroom design.

Our shower ranges are evolving all the time, and here we include the new cutting-edge Quartz™ Collection, the first-generation Wi-Fi connected, voice-activated smart showers and the exciting new range of Dream™ thermostatic concealed mixer showers that provide the widest choice of shower and bath fill combinations. We also feature our new tap ranges as complementary basin and bath brassware options.

Aqualisa Showers – take a closer look

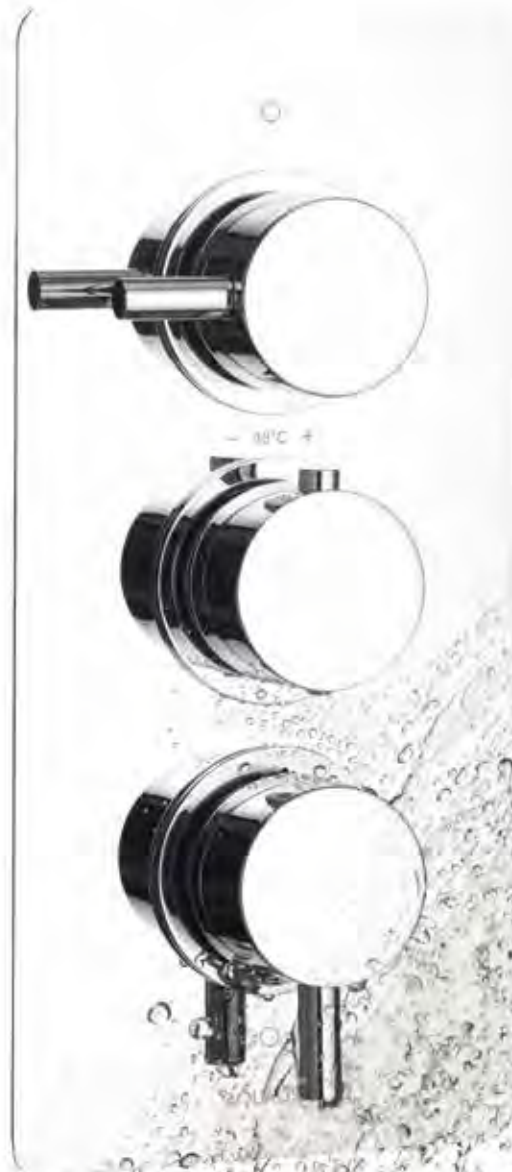

Dream™ concealed thermostatic mixer, page 40

SMART SHOWERS



PAGE 18

Designed to enhance you and your family's showering experience, our smart voice and app controlled showers come with a vast range of features and an optional remote control.

SMART SHOWER RANGES	18
TECHNICAL INFORMATION AND FEATURES	82

MIXER SHOWERS

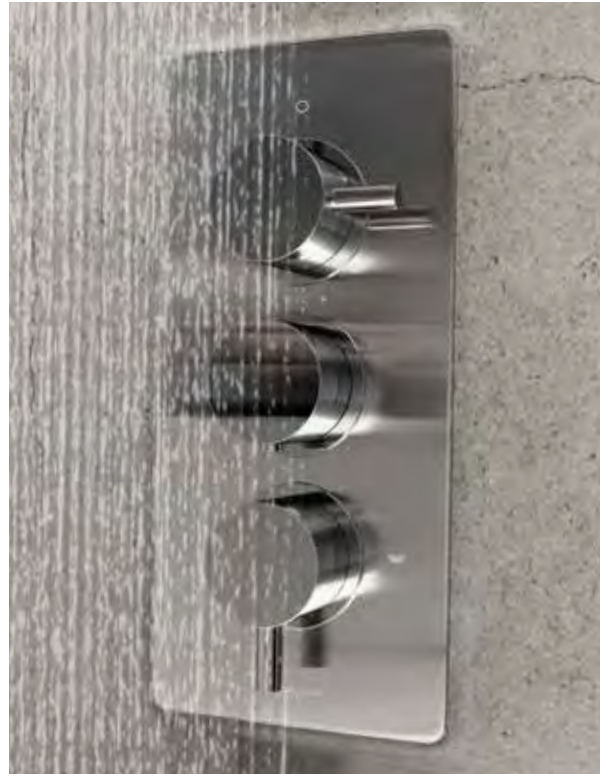

PAGE 38

Our range of high-performance mixer showers offer stylish designs to suit every bathroom.

MIXER SHOWER RANGES	38
TECHNICAL INFORMATION AND FEATURES	94

TAPS



PAGE 72

Our tap ranges are designed to complement a range of shower styles.

TAPS RANGES	72
TECHNICAL INFORMATION AND FEATURES	130

POWER SHOWERS



PAGE 60

Designed for gravity-fed systems, a power shower has an integral pump to boost flow and create an exceptional shower performance.

POWER SHOWER RANGES	60
TECHNICAL INFORMATION AND FEATURES	122





ELECTRIC SHOWERS



PAGE 64

Simple and economical electric showers are ideal where hot water is in constant demand.

ELECTRIC SHOWER RANGES	64
TECHNICAL INFORMATION AND FEATURES	124

USEFUL INFORMATION			
CHOOSE YOUR SHOWER	16	PUMPS	121
		ECOLOGICAL FEATURES	140
		RETROFITTING	142
CUSTOMER CARE	144	GUARANTEE	145
		For more information please visit us online at: www.aqualisa.co.uk Contact us on: enquiries@aqualisa.co.uk Phone us on: 01959 560 010	
		   	

SMART SHOWERS & BATHS

FOR EVERYDAY HOMES

Aqualisa introduced ground breaking digital technology for showers in 2001 and has remained the leading innovator in smart showering ever since. Unique features include one touch controls, remote activation and pre-set flow and temperature options that culminate in a truly personal showering experience.

Our pioneering technology works in all bathrooms, providing individual showering and bathing at your perfect temperature. As well as different shower configurations, the range includes smart bath filler options for total flexibility and reassurance for the whole family.



QUARTZ
TOUCH™

Overview Page 20
Technical Page 84



QUARTZ
CLASSIC™

Overview Page 24
Technical Page 86



QUARTZ
BLUE™

Overview Page 28
Technical Page 90



iSYSTEM™
SMART

Overview Page 32
Technical Page 92



AQUALISA

Hello





MIXER SHOWERS

THE PERFECT BLEND

With precise thermostatic temperature control, Aqualisa mixer showers combine hot and cold water supplies to deliver a superb, all round shower performance.

Quality, reliability and exceptional style choice run through our current mixer range. There are many different types of mixer showers, from popular exposed bar valves to stylish concealed valves. There is a style to fit every bathroom design.



MIDAS™ 220
Overview Page 50
Technical Page 108



MIDAS™ 110
Overview Page 52
Technical Page 110



MIDAS™ 100
Overview Page 54
Technical Page 112



COLT™
Overview Page 58
Technical Page 118



ASPIRE™ DL
Overview Page 46
Technical Page 102



AQUAVALVE™ 700
Technical Page 116



SIREN™ SL
Overview Page 56
Technical Page 114



AQUATIQUE™
Overview Page 48
Technical Page 106



DREAM™ CONCEALED
THERMOSTATIC MIXER
Overview Page 40
Technical Page 96



DREAM™ DL
Overview Page 44
Technical Page 100



AQUARIAN™
Technical Page 120



AQUAVALVE™ 609
Technical Page 104

POWER SHOWERS

INVIGORATE YOUR DAY

Our Aquastream™ power shower is the ideal solution if you are experiencing a weak shower due to low water pressure from your stored water supplies.

Easily installed, it mixes water from the hot and cold supplies to create and maintain your desired temperature. An integral pump will boost the water flow up to an exhilarating 18 litres per minute, offering a great shower anywhere in the house.



AQUASTREAM™

Overview Page 60

Technical Page 122

AQUALISA
AQUASTREAM



AQUALISA



ELECTRIC SHOWERS

THE FAMILY FAVOURITE

Aqualisa electric showers are simple to install and easy to use. As well as delivering an award winning performance, they have a contemporary design and finish.

The ideal solution for simple showering, an electric shower offers an endless economical flow of water and unlike other showering systems, will not use your stored hot water. The perfect solution for smaller or additional shower rooms or en-suites.



LUMI™ ELECTRIC

Overview Page 66

Technical Page 126



QUARTZ™ ELECTRIC

Overview Page 68

Technical Page 128

TAPS

CO-ORDINATED BRASSWARE

Aqualisa's tap ranges are designed to complement a range of shower styles. From the sleek linear form of Uptown™, the angular shaping of Downtown™ and ergonomic curves of Central™, there's a tap to suit every bathroom.

These quality tested and highly durable chrome brassware products carry up to 5 year guarantee against any manufacturing defect.

Our taps are easy to fit, with all fittings and connections included.



DOWNTOWN™

Overview Page 74
Technical Page 132



UPTOWN™

Overview Page 76
Technical Page 134



CENTRAL™

Overview Page 78
Technical Page 136





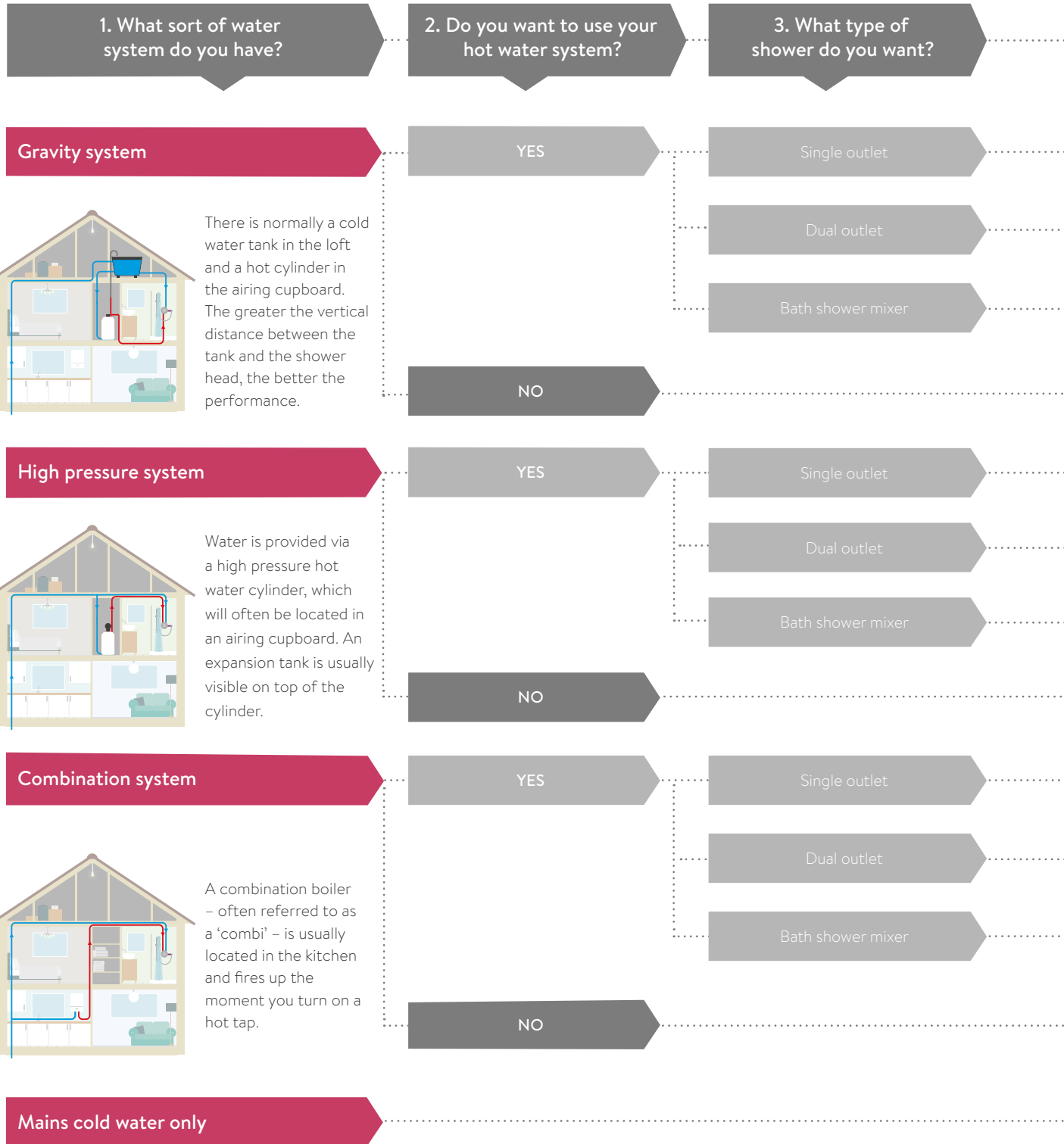

Choose your shower

This simple guide will help you choose your new shower or bath fill. First, identify your water system using the diagrams and descriptions below. Then, follow the chart on the right to choose the shower or bath fill that is suitable. For further help, call us on 01959 560 010.





4. Solutions available

ANY MIXER SINGLE OUTLET shower marked: LP  or ALL 
ANY MIXER SINGLE OUTLET shower with a separate booster pump
ANY SMART SINGLE OUTLET shower (Gravity Pumped variants)
MIDAS™ 100(BAR), MIDAS™ 110(S), MIDAS™ 220(S)

MIDAS™ 110(SC), MIDAS™ 220(SC), requires a separate booster pump
ANY SMART DUAL OUTLET shower (Gravity Pumped variants)
ANY DUAL OUTLET MIXER shower requires a separate booster pump

MIDAS™ 100(BSM), MIDAS™ 110(BSM), MIDAS™ 220(BSM), requires a separate booster pump
ANY SMART BATH/DUAL OUTLET shower with bath fill (Gravity Pumped variants)



ANY ELECTRIC Shower (water feed to be taken from cold mains only)

ANY MIXER SINGLE OUTLET shower marked: HP  or ALL 
ANY SMART SINGLE OUTLET shower (HP/Combi variants)

MIDAS™ 110(SC), 220(SC) or ANY DUAL OUTLET MIXER shower
ANY SMART DUAL OUTLET shower (HP/Combi variants)

MIDAS™ 100 (BSM), 110 (BSM), 220 (BSM) (Bath shower mixer variants)
ANY SMART BATH/DUAL OUTLET shower with bath fill (HP/Combi variants)
ANY DUAL OUTLET MIXER shower

ANY ELECTRIC Shower (water feed to be taken from cold mains only)

ANY MIXER SINGLE OUTLET shower marked: HP  or ALL 
ANY SMART SINGLE OUTLET shower (HP/Combi variants)

MIDAS™ 110(SC), 220(SC) or ANY DUAL OUTLET MIXER shower
ANY SMART DUAL OUTLET shower (HP/Combi variants)

MIDAS™ 100 (BSM), 110 (BSM), 220 (BSM) (Bath shower mixer variants)
ANY SMART BATH/DUAL OUTLET shower with bath fill (HP/Combi variants)
ANY DUAL OUTLET MIXER shower

ANY ELECTRIC Shower (water feed to be taken from cold mains only)

ANY ELECTRIC Shower (water feed to be taken from cold mains only)

SMART SHOWERS & BATH FILLS

	Overview	Technical information
Quartz Touch™		
Concealed	20	84
Exposed	22	84
Quartz Classic™		
Concealed	24	86
Exposed	26	86
Quartz Blue™		
Concealed	28	90
Exposed	30	90
iSystem™ Smart		
Concealed	32	92
Exposed	34	92





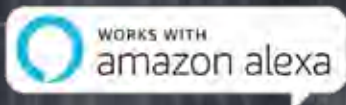
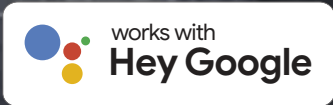

Quartz Touch™ concealed dual outlet shower with adjustable head and wall fixed drencher.
See page 84. QZST.A1.BV.DVFW.20/QZST.A2.BV.DVFW.20

QUARTZ TOUCH™

Concealed – single outlet, dual outlet and bath fill

Even the most advanced smart control remains simple and intuitive with Quartz Touch™, Aqualisa's most personal showering experience.

A choice of pre-set shower programmes or individual shower and bath settings for the whole family, from anywhere, is modern showering personified.

USER FEATURES

- Simple shower activation using the Aqualisa app, or voice control
- Wireless remote control
- Option to change flow to 'eco, medium or max'*
- Safe family showering with precise thermostatic temperature control and adjustable maximum temperature
- Eco mode setting saves up to 33% on your water consumption and unique proximity sensor reduces water flow when you step away from the shower*
- Intuitive LCD display
- Choose from 4 spray patterns and an optional 230mm fixed head or bath fill to customise your experience
- Up to 5 years parts and labour guarantee



CONNECTED FEATURES

- Wifi, Mobile App, works with Hey Google or Amazon Alexa for voice control
- 3 pre-set profiles and create your own
- Multiple showers can be operated from 1 app
- Timer feature to set your shower duration
- Indicative usage dashboard tracks and records water usage, time and estimates costs
- Safety feature, protects the shower users from others adjusting the shower remotely via the app



For full range and features **See page 84**

*Feature may not operate on combination boiler systems.

QUARTZ TOUCH™

Exposed – single outlet, dual outlet and bath fill

Quartz Touch™ is available as a single or dual outlet option, with the choice of an adjustable handset featuring 4 spray patterns and an optional 230mm fixed drencher head. The shower can also divert to a programmed bath fill function.

It's easy to install with all approved domestic water supplies and the app makes it incredibly simple to create and store your shower choices, all activated from your phone, a remote control on the wall or by using voice activation.

USER FEATURES

- Simple shower activation using the Aqualisa app, or voice control
- Wireless remote control
- Option to change flow to 'eco, medium or max'*
- Safe family showering with precise thermostatic temperature control and adjustable maximum temperature
- Eco mode setting saves up to 33% on your water consumption and unique proximity sensor reduces water flow when you step away from the shower*
- Intuitive LED display
- Choose from 4 spray patterns and an optional 230mm fixed head or bath fill to customise your experience
- Up to 5 years parts and labour guarantee



CONNECTED FEATURES

- Wifi, Mobile App, works with Hey Google or Amazon Alexa for voice control
- 3 pre-set profiles and create your own
- Multiple showers can be operated from 1 app
- Timer feature to set your shower duration
- Indicative usage dashboard tracks and records water usage, time and estimated costs
- Safety feature, protects the shower users from others adjusting the shower remotely via the app



Easily upgrade an exposed mixer shower with the Quartz Smart Retrofit Shower. See page 142.

*Feature may not operate on combination boiler systems.



works with
Hey Google

WORKS WITH
amazon alexa

*Quartz Touch™ exposed with adjustable head.
See page 84. QZST.A1.EV.20/QZST.A2.EV.20*



For full range and features **See page 84**



works with
Hey Google

WORKS WITH
amazon alexa

Quartz Classic™ concealed dual outlet shower with adjustable head and wall fixed drencher.
See page 86. QZD.A1.BV.DVFW.20/QZD.A2.BV.DVFW.20

QUARTZ CLASSIC™

Concealed – single outlet, dual outlet and bath fill

A great shower has just got better.

What more can be said about Quartz Classic™? Lasting good looks, a pioneer of shower technology and a UK best seller. Now, it takes its rightful place in the smart bathroom as a Wifi connected shower control.

You can expect the same level of performance from this market leading shower but with the added convenience of control from your smart device, a remote control on the wall or by a simple voice command.

USER FEATURES

- One touch start and stop control
- Simple shower activation using the Aqualisa app, or voice control
- Optional remote control
- Safe family showering with precise thermostatic temperature control and adjustable maximum temperature
- Eco mode setting saves up to 33% on your water consumption*
- Intuitive LED display
- 105mm adjustable head, featuring 4 spray patterns and an optional 230mm fixed head or bath fill to customise your experience
- Easy to use button one touch start/stop control, divert optional
- Up to 5 years parts and labour guarantee



CONNECTED FEATURES

- Wifi, Mobile App, works with Hey Google or Amazon Alexa for voice control
- Multiple showers can be operated from 1 app
- Timer feature to set your shower duration
- Indicative usage dashboard tracks and records water usage, time and estimated costs
- Safety feature, protects the shower users from others adjusting the shower remotely via the app



For full range and features **See page 86**

*Feature may not operate on combination boiler systems.

QUARTZ CLASSIC™

Exposed – single outlet, dual outlet and bath fill

Quartz Classic™ is available as a single or dual outlet option, with the choice of an adjustable handset featuring 4 spray patterns and an optional 230mm fixed drencher head.

The shower can divert to a programmed bath fill function, but Quartz Classic™ is also available as a control for bath fill only. The familiar Quartz look and feel is set to continue at the forefront of showering excellence as part of the smart home revolution.

USER FEATURES

- One touch start and stop control
- Simple shower activation using the Aqualisa app, or voice control
- Remote control
- Safe family showering with precise thermostatic temperature control and adjustable maximum temperature
- Eco mode setting saves up to 33% on your water consumption*
- Intuitive LED display
- 105mm adjustable head, featuring 4 spray patterns and an optional 230mm fixed head or bath fill to customise your experience
- Easy to use button one touch start/stop control, divert optional
- Up to 5 years parts and labour guarantee

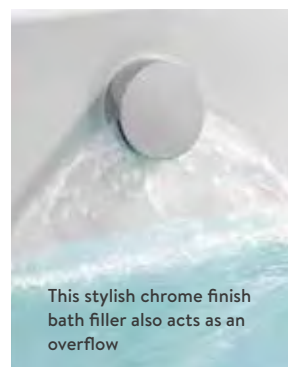

This stylish chrome finish bath filler also acts as an overflow

CONNECTED FEATURES

- Wifi, Mobile App, works with Hey Google or Amazon Alexa for voice control
- Multiple showers can be operated from 1 app
- Timer feature to set your shower duration

- Indicative usage dashboard tracks and records water usage, time and estimated costs
- Safety feature, protects the shower users from others adjusting the shower remotely via the app

*Feature may not operate on combination boiler systems.

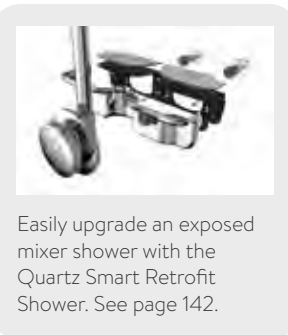



works with
Hey Google

WORKS WITH
amazon alexa

Quartz Classic™ exposed shower with adjustable head.
See page 86. QZD.A1.EV.20/QZD.A2.EV.20



For full range and features **See page 86**



works with
Hey Google

WORKS WITH
amazon alexa

Quartz Blue™ concealed dual outlet concealed with adjustable head and wall fixed drencher.
See page 90. QZSB.A1.BV.DVFW.20/QZSB.A2.BV.DVFW.20

QUARTZ BLUE™

Concealed – single outlet, dual outlet and bath fill

Quartz Blue™ is the ideal introduction to smart shower routines that will change the way you take a shower.

With its individual programme features and Wifi connectivity, the minimalist designer look of Quartz Blue™ conceals the level of intelligent technology built into this compact but perfectly formed, shower control.

USER FEATURES

- One touch start and stop control
- Simple shower activation using the Aqualisa app, or voice control
- Safe family showering with precise thermostatic temperature control and adjustable maximum temperature
- Eco mode setting saves up to 33% on your water consumption*
- Intuitive LED display
- 90mm adjustable head, featuring 4 spray patterns and an optional 200mm fixed head or bath fill to customise your experience
- Up to 5 years parts and labour guarantee



CONNECTED FEATURES

- Wifi, Mobile App, works with Hey Google & Amazon Alexa for voice control
- Multiple showers can be operated from 1 app
- Timer feature to set your shower duration
- Indicative usage dashboard tracks and records water usage, time and estimated costs
- Safety feature, protects the shower users from others adjusting the shower remotely via the app



For full range and features **See page 90**

*Feature may not operate on combination boiler systems.

QUARTZ BLUE™

Exposed – single outlet, dual outlet

Quartz Blue™ is available as a single or dual outlet option, with an adjustable head featuring 4 spray patterns and an optional 200mm fixed drencher head. The shower can also divert to a programmed bath fill function.

Expand your showering expectations with control from the app or your voice for flexibility and convenience. Straightforward installation makes it simple to experience a new world of sheer, indulgent showering.

USER FEATURES

- One touch start and stop control
- Simple shower activation using the Aqualisa app, or voice control
- Safe family showering with precise thermostatic temperature control and adjustable maximum temperature
- Eco mode setting saves up to 33% on your water consumption*
- Intuitive LED display
- 90mm adjustable head, featuring 4 spray patterns and an optional 200mm fixed head to customise your experience
- Up to 5 years parts and labour guarantee



CONNECTED FEATURES

- Wifi, Mobile App, works with Hey Google & Amazon Alexa for voice control
- Multiple showers can be operated from 1 app
- Timer feature to set your shower duration
- Indicative usage dashboard tracks and records water usage, time and estimated costs
- Safety feature, protects the shower users from others adjusting the shower remotely via the app



Easily upgrade an exposed mixer shower with the Quartz Smart Retrofit Shower. See page 142.

*Feature may not operate on combination boiler systems.



works with
Hey Google

WORKS WITH
amazon alexa

Quartz Blue™ exposed with adjustable head.
See page 90. QZSB.A1.EV.20/QZSB.A2.EV.20



For full range and
features **See page 90**

iSYSTEM™ SMART

Concealed – single outlet, dual outlet

The distinctive linear design is an attractive style for contemporary bathrooms, and, with new smart features incorporated, meets every expectation of a modern showering space.

Versatile shower settings are easily activated by voice command or remote control and will suit different individual preferences, but always with high performance and safe temperatures guaranteed.

FEATURES

- One touch start/stop control
- Simple shower activation using the Aqualisa app, or voice control
- Boost or divert your shower at the touch of a button
- Safe family showering with precise thermostatic temperature control & adjustable maximum temperature
- Eco mode setting saves up to 33% on your water consumption*
- Thermostatically blended showering
- Shower ready LED lighting display
- Optional hard wired remote control



CONNECTED FEATURES

- Wifi connected
- Voice command (Hey Google and Amazon Alexa compatible)
- Timer feature allows you to set your shower duration
- App dashboard tracks and records water usage, time & estimated costs
- Safety feature, protects the shower users from others adjusting the shower remotely via the app



For full range and features **See page 92**

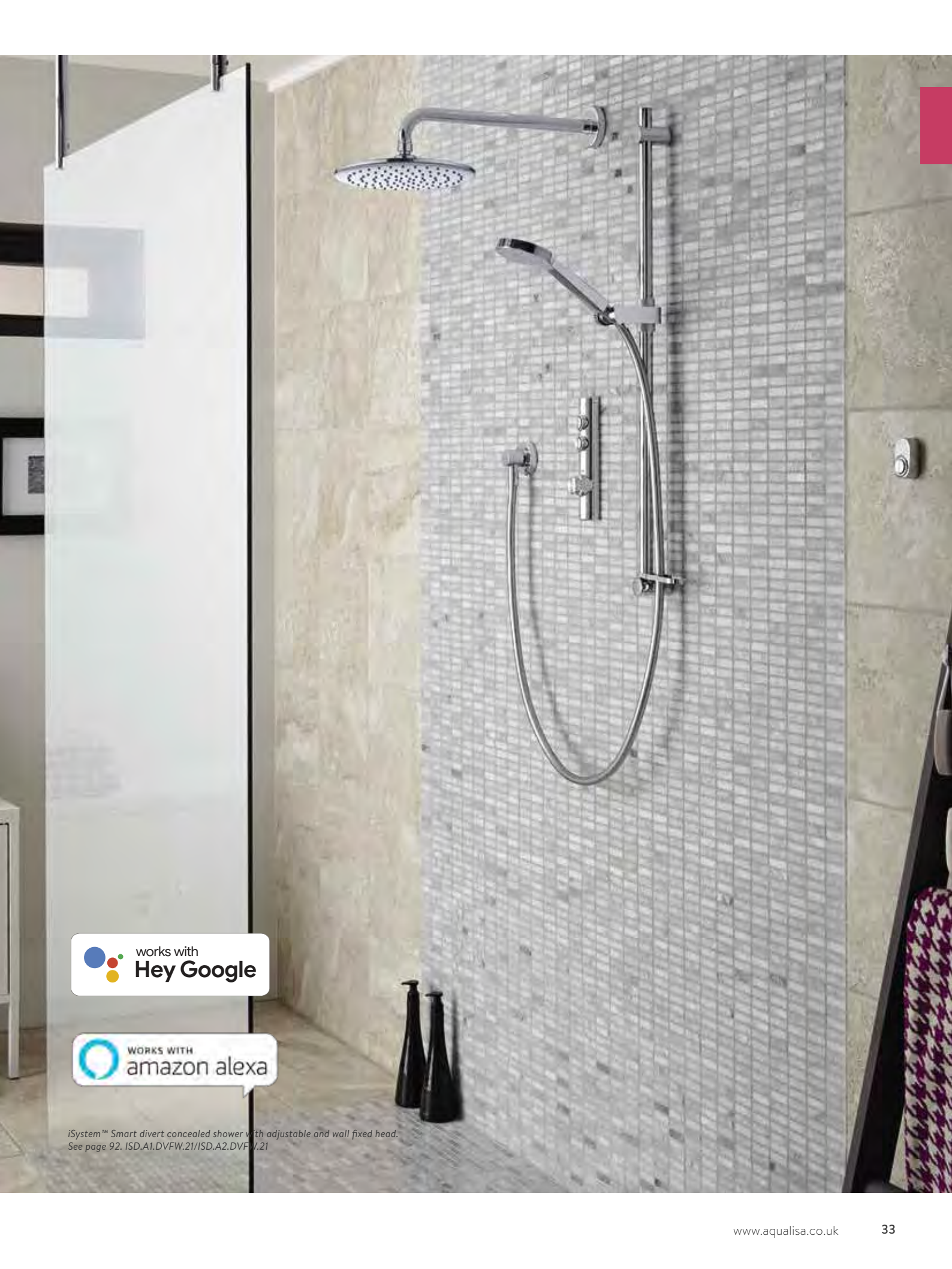

works with
Hey Google

WORKS WITH
amazon alexa

*iSystem™ Smart divert concealed shower with adjustable and wall fixed head.
See page 92. ISD.A1.DVFW.21/ISD.A2.DVFW.21*

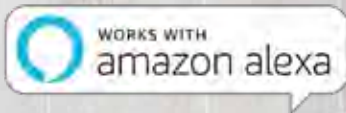

*iSystem™ Smart exposed with adjustable head and remote.
See page 92. ISD.A1.EV.21/ISD.A1.EV.21/ISD.B3.DS.14*

iSYSTEM™ SMART

Exposed – single outlet, dual outlet

The integrated control and riser rail design of the iSystem™ Smart exposed shower is a great way to get into smart showering. The straightforward connections through the rail to the intelligent Aqualisa SmartValve™ optimises space in the showering area and avoids disruption to tiles and decor.

Now, with all the advantages of voice activation, pre-set shower programmes and mobile data on water usage and cost, access to modern showering technology has never been easier.

FEATURES

- One touch start/stop control
- Simple shower activation using the Aqualisa app, or voice control
- Boost or divert your shower at the touch of a button
- Safe family showering with precise thermostatic temperature control & adjustable maximum temperature
- Eco mode setting saves up to 33% on your water consumption*
- Thermostatically blended showering
- Shower ready LED lighting display
- Optional hard wired remote control



CONNECTED FEATURES

- Wifi connected
- Voice command (Hey Google and Amazon Alexa compatible)
- Timer feature allows you to set your shower duration

- App dashboard tracks and records water usage, time & estimated costs
- Safety feature, protects the shower users from others adjusting the shower remotely via the app



For full range and features **See page 92**

*Feature may not operate on combination boiler systems.

TECHNICAL INFORMATION

SMART

QUARTZ TOUCH™

QUARTZ CLASSIC™

DUAL OUTLET

SINGLE OUTLET

DUAL OUTLET

SINGLE OUTLET

Configurations available				
Concealed valve (for less cluttered bathroom)	•	•	•	•
Exposed valve (ideal for easy installation)	•	•	•	•
Bath shower combination	•		•	
Divert to more than one outlet	•		•	
Controller features				
Flow control*	Variable	Variable	Single	Single/Boost
One touch start/stop	•	•	•	•
Easy to use dual outlet button	•		•	
Smooth glide temperature control or lever	•	•	•	•
'Cool to touch' controls	•	•	•	•
Illuminated LED display			•	•
Colour screen control menu	•	•		
Proximity sensor	•	•		
Controller finish	Glass front plus colour accent	Glass front plus colour accent	Chrome plated	Chrome plated
Remote control (optional accessory)				
Remote control	Wireless	Wireless	Wired	Wired
Shower heads, hoses and rails and accessories				
Adjustable head size (diameter)	105mm	105mm	105mm	105mm
Number of sprays on handsets	4	4	4	4
Drencher head (diameter)	230mm	230mm	230mm	230mm
Long adjustable shower rail (concealed only)	700mm	700mm	700mm	700mm
Hose style	Ribbed chrome	Ribbed chrome	Ribbed chrome	Ribbed chrome
Retrofit wall plate			•	•
Corner fixing brackets for exposed showers	•	•	•	•
Rail extension kit for exposed showers	•	•	•	•
Eco features				
Water saving spray patterns (adjustable head only)	•	•	•	•
Eco-setting in processor*	•	•	•	•
Eco mode in control menu	•	•		
Proximity sensor*	•	•		

*Feature may not operate on combination boiler systems.

QUARTZ BLUE™

iSYSTEM™ SMART

DUAL OUTLET

SINGLE OUTLET

DUAL OUTLET

SINGLE OUTLET

QUARTZ BLUE™		iSYSTEM™ SMART	
DUAL OUTLET	SINGLE OUTLET	DUAL OUTLET	SINGLE OUTLET
•	•	•	•
•	•	•	•
•			
•		•	
Single	Single	Single/Boost	Single/Boost
•	•	•	•
•		•	
•	•	•	•
•	•	•	•
•	•	•	•
Chrome plated	Chrome plated	Chrome plated	Chrome plated
		Wired	Wired
90mm	90mm	100mm	100mm
4	4	1	1
200mm	200mm	230mm	230mm
700mm	700mm	700mm	700mm
Ribbed chrome	Ribbed chrome	Smooth chrome	Smooth chrome
•	•		
•	•	•	•
•	•		
•	•	•	•



All our shower heads, kits and accessories have a 2 year guarantee



All our controllers and SmartValves™ have a 5 year guarantee

MIXER & POWER SHOWERS

	Overview	Technical information
Mixer Showers		
Dream™ Concealed Thermostatic Mixer	40	96
Dream™ DL	44	100
Aspire™ DL	46	102
Aquavalue™ 609		104
Aquatique™	48	106
Midas™ 220	50	108
Midas™ 110	52	110
Midas™100	54	112
Siren™ SL	56	114
Aquavalue™ 700		116
Colt™	58	118
Aquarian™		120
Mach pumps		121
Power Showers		
Aquastream™	60	122





DREAM™ CONCEALED THERMOSTATIC MIXER

Round - with fixed & adjustable head, hand shower and bath fill

Six configurations, including the popular slim wand handset, feature various combinations of shower and bath systems, both in round or square styling.

Dual outlet models can be installed in a dedicated showering area or over the bath and deliver excellent water flow rates from all types of water system.

FEATURES

- Solid brass body
- Exceptional temperature safety assurance
- 105mm 4 function handset with rub clean nozzles, including Eco mode setting which saves up to 25% on your water consumption
- Minimal sleek design and slim pushfit metal wall plate for easy assembly
- 1.5m smooth hose
- Chrome plated Pinch Grip™ handset holder
- Round control dials
- Chrome plated Pinch Grip™
- Slim 2mm profile, push fit wall plate
- Suitable for all water systems
- 5 year guarantee



For full range and features **See page 96**



Dream™ concealed triple outlet mixer shower with adjustable head, wall mounted drencher and bath fill.

See page 96. DRMDCV3.ADFWBTX.RND

DREAM™ CONCEALED THERMOSTATIC MIXER

Square - with fixed & adjustable head, hand shower and bath fill

From the high-grade polished chrome finish to the one piece solid brass valve, the Dream range shouts quality from front to back.

Smooth turn dials and different shower modes all add to a premium shower experience. Concealed mixer valves are built-in behind the wall, enabling the shower controls to sit flush on the tiles.

FEATURES

- Solid brass body
- Exceptional temperature safety assurance
- 109mm adjustable head with 3 spray patterns
- Minimal sleek design and slim pushfit metal wall plate for easy assembly
- 1.5m smooth hose
- Chrome plated quarter turn handset holder
- Square control dials
- Suitable for all water systems
- 5 year guarantee

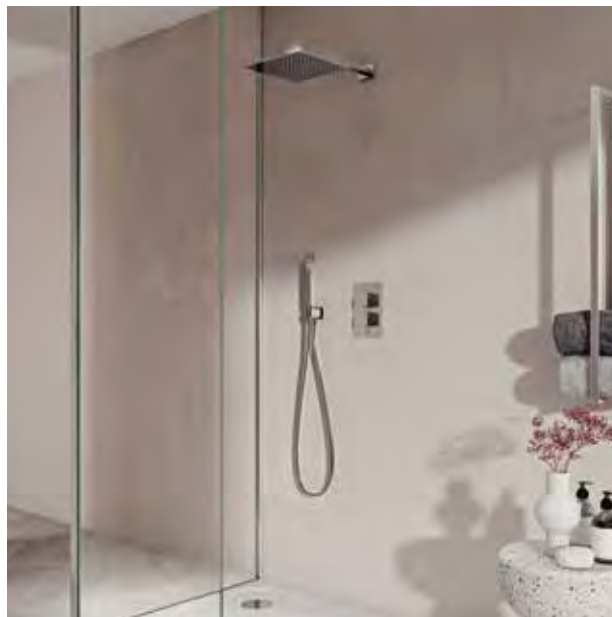

For full range and features **See page 98**



Dream™ concealed triple outlet mixer shower with adjustable head, wall mounted drencher and bath fill.

See page 98. DRMDCV3.ADFWBTX.SQR



*Dream™ concealed mixer shower with adjustable head
See page 100. DRM001CA*

DREAM™ DL

Dual lever mixer shower with fixed or adjustable head

A stunning range of thermostatic mixer showers packed with desirable features, such as dual lever, all metal controls and our renowned bi-metallic technology.

FEATURES

- Luxurious quality and design
- Aqualisa unique bi-metallic thermostatic technology for precise, reliable performance
- Temperature override button for extra safety
- Separate on/off and temperature control levers for greater control
- Metal controls with luxury chrome finish
- 'Eco' spray setting delivers up to 25% water saving without compromising performance
- Fixed and adjustable 4 spray 105mm Harmony™ shower heads with easy clean nozzles to help reduce limescale build-up
- Suits all approved UK domestic water systems



Harmony™ shower heads offer 4 spray patterns for sensational performance.



For full range and features **See page 100**

ASPIRE™ DL

Mixer shower with fixed or adjustable head

Sophisticated, sleek and stylish, the Aspire™ dual lever shower combines timeless good looks with precise control over temperature and water flow.

The perfect choice for exposed shower refurbishment, upgrades and replacements, the elbows are easy to adjust, making it a favourite for installers.

FEATURES

- Luxury brass valve with chrome finish
- Dual lever for effective flow and temperature control
- Generously proportioned 105mm Harmony™ shower head with 4 impressive spray patterns
- 'Eco' spray setting delivers up to 25% water saving
- Easy clean nozzles to help reduce limescale from shower heads
- Exposed and concealed systems are available
- Suits all approved domestic UK water systems
- Adjustable inlet centres



For full range and features **See page 102**



*Aspire™ DL concealed mixer shower with adjustable head.
See page 102. ASP001CA*



Aquatique™ thermo exposed mixer shower with fixed 8" drencher head.
See page 106. 500.10.04 & 581.04

AQUATIQUE™

Mixer shower with adjustable or drencher head

The Aquatique™ range combines traditional elegance with Aqualisa's thermostatic technology, for an unsurpassed shower experience.

Classic styling meets sensational showering and the timeless luxury of solid brass valves and shower heads. Aquatique™ is a stunning addition to any bathroom. A shower that's as stylish as it is invigorating.

FEATURES

- Timeless, classical styling
- Luxury brass shower valve
- Choice of heads in chrome or gold finish
- Exposed and concealed systems available
- Aqualisa's unique bi-metallic thermostatic technology for precise, reliable performance
- Automatic cut-off, should hot or cold water fail, makes for safer showering
- Separate on/off and temperature control



For full range and features **See page 106**

MIDAS™ 220

Shower, bath shower mixer and shower column

Midas™ 220's sleek space saving design combined with quality metal finish and superb performance, makes it the perfect contemporary shower for a modern family bathroom. A brass valve with a slimline space saving design.

Choose between shower or bath/shower mixer to create a stylish coordinated look.

FEATURES

- Brass valve with slimline, space saving design
- Temperature override button for family-safe showering
- Integrated diverter for easy switching between outlets (shower column and bath/shower mixer)
- 105mm Harmony shower head with 4 spray patterns
- 230mm fixed drencher head
- Smooth chrome hose
- Quality metal construction



Simple Pinch Grip height adjustment



For full range and features **See page 108**



*Midas™ 220 shower column with adjustable head.
See page 108. MD220SC*



*Midas™ 110 bar mixer shower with fixed and adjustable head.
See page 110. MD110S*

MIDAS™ 110

Shower, bath shower mixer and shower column

Stylish looks combined with high performance, convenience and assured safety. The Midas™ 110 range boasts features such as safe touch controls and an integrated diverter to make it the perfect choice for all family bathrooms.

Features include all metal controls for style, durability and reliability.

FEATURES

- Stylish modern brass valve
- Temperature override button for family-safe showering
- Integrated diverter for easy switching between outlets (shower column and bath/shower mixer)
- Adjustable 4 spray 105mm Harmony™ shower head with easy clean nozzles to help reduce limescale build-up
- 'Eco' spray setting delivers up to 25% water saving without compromising performance
- 215mm fixed drencher head
- Quality metal construction



Harmony™ shower heads offer four spray patterns for sensational performance.



For full range and features **See page 110**



*Midas™ 100 bar mixer shower with adjustable head.
See page 112. MD100BAR*

MIDAS™ 100

Shower and bath shower mixer with adjustable head

Smart, modern looks and outstanding performance make the Midas™ 100 shower and bath shower mixer range the perfect choice for the family bathroom.

The slimline bar valve of the Midas™ 100 features integrated flow and temperature controls, whilst safety is assured with a temperature override button.

FEATURES

- Slim, stylish bar mixer and bath shower mixer range
- Separate temperature and flow control
- Temperature override button for added family safety
- 'Eco' spray setting delivers up to 25% water saving
- Quality metal construction
- Easy clean nozzles to help reduce limescale build-up
- Adjustable 90mm Harmony™ head with a choice of 4 impressive spray patterns
- Midas™ 100 showers are suitable for all approved UK domestic water systems
- Bath shower mixers suit high pressure water systems only

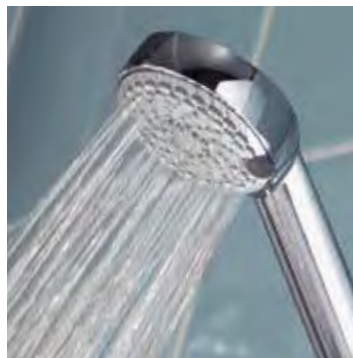

5 year guarantee on Midas™ shower valves and 2 years on shower heads and kits will give you real peace of mind.



For full range and features **See page 112**



*Siren™ SL exposed mixer shower with adjustable head.
See page 114. SRN001EA*

SIREN™ SL

Mixer shower with adjustable head

Family friendly shower design that is a joy to use. Siren™ SL's exposed and concealed single lever controls make showering simple. Comes complete with an adjustable Harmony™ shower head with 4 spray patterns, including 'eco' spray.

A great option for easy refurbishment. The Siren™ SL exposed has clever adjustable elbows making it perfect for new refurbishment solutions.

FEATURES

- Luxury brass valve with chrome finish
- Easy to use, single lever control
- Family-safe thermostatic showering
- Harmony™ head with a choice of 4 impressive spray patterns
- The 'Eco' spray setting uses up to 25% less water
- Easy clean nozzles help reduce limescale build up
- Choose from exposed or concealed shower systems
- Suits all approved UK domestic water systems
- Adjustable inlet centres



For full range and features **See page 114**

COLT™

Mixer shower with adjustable head

Colt™ is an Aqualisa thoroughbred with style, quality and performance that comes as standard. A great looking shower with great performance.

Delivering the perfect temperature and control, coupled with striking styling in polished chrome. The Colt™ is the perfect addition for family bathrooms.

FEATURES

- Aqualisa's unique bi-metallic thermostatic technology for precise, reliable performance
- Exposed and concealed systems available
- Separate on/off and temperature control
- Temperature override button
- 90mm Harmony™ head with a choice of 4 impressive spray patterns
- 'Eco' spray setting delivers up to 25% water saving
- Suitable for all approved UK domestic water systems



*Colt™ concealed mixer shower with adjustable head.
See page 118. COLT001EA*



For full range and features **See page 118**



*Colt™ concealed mixer shower with adjustable head.
See page 118. COLT001CA*



Aquastream™ Thermo mixer power shower with adjustable head.
See page 122. 813.40.20

AQUASTREAM™

Power shower with adjustable head

Boasting true power shower performance, and designed specifically for gravity systems, the ergonomic thermostatic power shower with its own integrated pump delivers exceptional showering performance.

Perfect if space is limited, the Aquastream™ power shower is surface mounted so there's less likely to be damage to tiling.

FEATURES

- Integrated booster pump for power shower performance
- Separate flow and temperature control
- Two flow settings to make the most of your plumbing system
- 90mm Harmony™ head with a choice of 4 impressive spray patterns
- 'Eco' spray setting delivers up to 25% water saving
- Easy clean nozzles help reduce limescale build-up
- For gravity systems only
- 3 colour variants

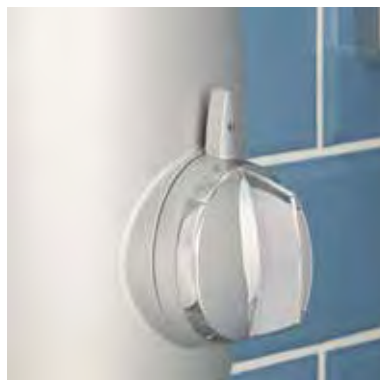

Features include two flow settings to make the most of your plumbing system



For full range and features **See page 122**

TECHNICAL INFORMATION

MIXER SHOWERS

	DREAM™ CONCEALED ROUND	DREAM™ CONCEALED SQUARE	DREAM™ DL	ASPIRE™ DL	AQUATIQUE™	AQUAVALVE™ 700
Configurations available						
Concealed valve (for less cluttered bathroom)	•	•	•	•	•	•
Exposed valve (ideal for easy installation)				•	•	•
Bath shower combination	•	•				
Divert to more than one outlet	•	•				
Controller features						
Flow control	Variable	Variable	Single	Variable	Single	Single
Temperature override button	•	•	•			
Smooth glide temperature control	•	•	•	•	•	•
'Safe touch' controls	•	•	•	•	•	•
Controller finish	Chrome plated luxury brass	Chrome plated luxury brass	Chrome plated luxury brass	Chrome plated luxury brass	Chrome or gold plated luxury brass/ Ceramic	Chrome plated luxury brass
'Cool touch' valve	•	•	•	•	•	•
Shower kits						
Adjustable head size (diameter)	105mm	109mm	105mm	105mm	60mm	90mm
Number of sprays on handsets	4	3	4	4	1	3
Drencher head or fixed head (diameter)	250mm	250mm	105mm	105mm	125/200mm	90mm
Hose style	Smooth	Smooth	Ribbed	Ribbed	Ribbed	Ribbed
Eco features						
Water saving spray patterns	•	•	•	•	•	
Installer features						
Easy fit installation				• Exposed		
Retrofit suitability				• Exposed		
Guarantee period						
Valve and fittings	5	5	5	5	5	3
Shower heads, rails and fittings	2	2	2	2	2	2

TECHNICAL INFORMATION

POWER SHOWER

MIDAS™ 220	MIDAS™ 110	MIDAS™ 100	SIREN™ SL	COLT™	AQUASTREAM™ THERMO
			•	•	
•	•	•	•	•	•
•	•	•			
•	•	•			
Variable	Variable	Variable	Variable	Single	Single/Boost
•	•	•		•	
•	•	•	•	•	•
•	•	•	•	•	•
Chrome plated luxury brass	Chrome plated luxury brass	Chrome plated	Chrome plated luxury brass	Chrome plated	Satin/chrome White White/chrome
•	•		•	•	•
105mm	105mm	90mm	90mm	90mm	90mm
4	4	4	4	4	4
230mm	215mm				
Smooth	Ribbed	Ribbed	Ribbed	Ribbed	Ribbed
•	•	•	•	•	•
•	•	•	• Exposed		•
•	•	•	• Exposed		•
5	5	5	5	2	3
2	2	2	2	2	2

ELECTRIC SHOWERS

	Overview	Technical information
Lumi™ Electric	66	126
Quartz™ Electric	68	128

All our electric showers carry the European Water Label and are rated Energy Efficiency 'A'





AQUALISA



LUMI™ ELECTRIC

Electric shower with adjustable head

Make the ultimate style statement and illuminate your senses with Aqualisa Lumi™ Electric. Featuring a mirrored glass fascia and illuminated panel.

Aqualisa Lumi™ has redefined electric showers. A design statement of mirror and light that offers you a complete sensorial experience every day. Start and stop the shower with the sensory touch control and immerse yourself under the luxurious Harmony™ shower head.

FEATURES

- Luxury, mirrored glass fascia with illuminated panel
- Sensory touch start/stop control
- Aerospace grade, brushed stainless steel temperature control
- Unique 'Over Temperature Protection' system for safer family showering
- Harmony™ Electric head with 5 spray settings
- Anti-twist hose connection
- Easy clean nozzles reduce limescale build-up
- White/Chrome or Chrome trim options
- Performance ratings: 8.5kW, 9.5kW and 10.5kW (@240V)
- Suitable for mains cold water systems only



For full range and features **See page 126**



*Aqualisa Lumi™ Electric shower with adjustable head.
See page 126. LME8501*



*Aqualisa Quartz™ Electric shower with adjustable head.
See page 128. QZE8501*

QUARTZ™ ELECTRIC

Electric shower with adjustable head

Impressive design, impressive user features, impressive installation benefits and an impressive showering experience – what more could you want?

The Quartz™ Electric's simple and compact design offers effective efficient showering.

FEATURES

- Simple to use 'smooth glide' control with LED indicator
- Delivers instant hot showers with no demand on stored hot water
- Unique 'Over Temperature Protection' system for safer showering for all the family
- Delayed shutdown flushes away residual hot water, reducing limescale build-up
- Harmony™ Electric head with 5 spray settings
- Anti-twist hose connection
- Easy to clean nozzles reduce limescale build up
- Choice of 3 great finishes
- Generous footprint for easy shower replacement
- Available in 8.5kW, 9.5kW and 10.5kW performance ratings (@240V)



For full range and features **See page 128**

ELECTRIC SHOWERS

	LUMI™ ELECTRIC	QUARTZ™ ELECTRIC
Configurations available		
White / Chrome	•	•
Chrome	•	•
Graphite / Chrome		•
Power Rating – 8.5 kW	•	•
Power Rating – 9.5 kW	•	•
Power Rating – 10.5 kW	•	•
Shower heads, hoses and rails accessory		
Adjustable head size (diameter)	105mm	105mm
Number of sprays on handset	5	5
Rub clean nozzles on shower head	•	•
User features		
Sensory touch start/stop control	•	
Soft touch push button start/stop control		•
Illuminated panel	•	
Separate power and temperature controls	•	•
Easy glide temperature control	•	•
Safety features		
Phased Shutdown Flushes residual hot water out of system	•	•
Heat sensor Safeguards user from high temperatures	•	•
Approvals		
European Water Label	•	•
BEAB	•	•
CE	•	•



Our Electric showers and shower kits have a 2 year guarantee

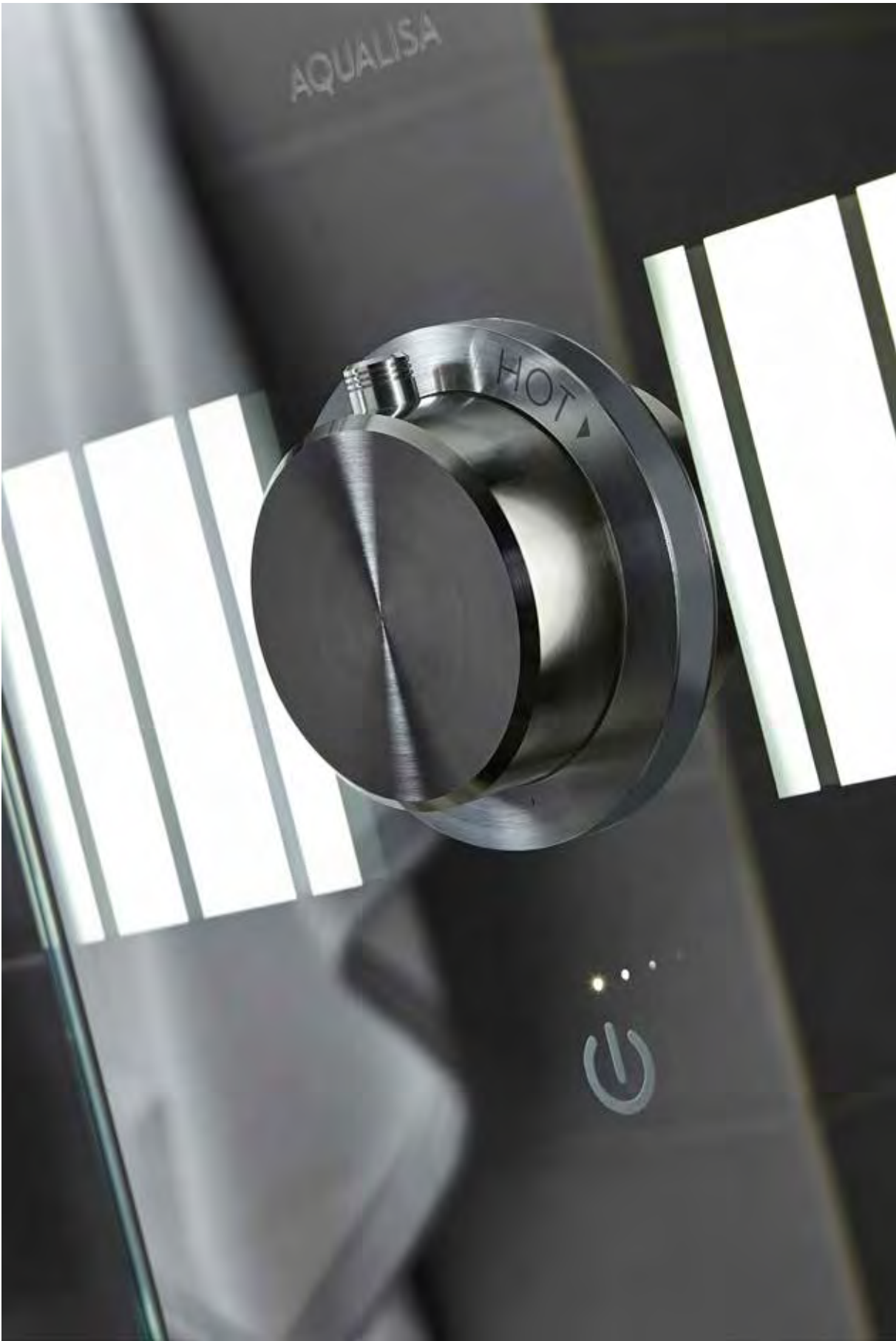

TAPS

	Overview	Technical information
Downtown™	74	132
Uptown™	76	134
Central™	78	136







*Downtown™ large basin mixer tap.
See Page 132. DT.LPT.CH*

DOWNTOWN™

A soft square lever style that suits bold customised bathroom designs.

The minimalist aesthetic of Quartz Touch™ is matched by the modern chamfered design of Downtown™ taps to maintain a stylish and unified feel throughout the bathroom.

All taps are WRAS approved.

FEATURES

- Four tap options - small mixer, large mixer, deck mounted bath filler and bath shower mixer
- Angular soft square lever
- Aqualisa branded
- LP/HP systems
- Brass body with zinc handles
- Polished chrome finish colour
- 5 year guarantee (if product is registered)



For full range and features **See page 132**

UPTOWN™

A popular pin lever style that is easy to coordinate with concealed mixer showers.

The co-ordination of Uptown™ taps with Dream™ concealed mixer shower immediately creates a style identity from a distinctive mix of different surfaces and materials.

All taps are WRAS approved.

FEATURES

- Four tap options - small mixer, large mixer, deck mounted bath filler and bath shower mixer
- The popular pin lever style is easy to operate
- Aqualisa branded
- LP/HP systems
- Brass body with zinc handles
- Polished chrome finish colour
- 5 year guarantee (if product is registered)



For full range and features **See page 134**



*Uptown™ small basin mixer tap.
See page 134. CB.SPT.19*



*Central™ large basin mixer tap.
See page 136. CT.LPT.CH*

CENTRAL™

The rounded paddle lever style is ideal for a contemporary bathroom look.

Shown here with the popular Midas 220™ dual outlet valve, the Central™ rounded lever design complements a wide range of shower choices, adding a distinctive style element to the overall bathroom scheme.

All taps are WRAS approved.

FEATURES

- Four tap options - small mixer, large mixer, deck mounted bath filler and bath shower mixer
- Rounded paddle lever style
- Aqualisa branded
- LP/HP systems
- Brass body with zinc handles
- Polished chrome finish colour
- 5 year guarantee (if product is registered)



For full range and features **See page 136**

TECHNICAL INFORMATION

TAPS

DOWNTOWN™

UPTOWN™

	SINGLE BASIN MIXER TAP	LARGE BASIN MIXER TAP	DECK MOUNTED BATH FILLER	BATH SHOWER MIXER	SINGLE BASIN MIXER TAP
Pressure					
Min pressure required	0.2 bar	0.2 bar	0.2 bar	0.2 bar	0.2 bar
Max pressure required	5 bar	5 bar	5 bar	5 bar	5 bar
Inlet Connections					
2 x braided hose with 1/2" BSP female	•	•			•
2 x 3/4" BSP			•	•	
Fittings					
Rear inlet supply positions			Hot/left, cold/right (as viewed from the front)	Hot/left, cold/right (as viewed from the front)	
Tap Holes	1	1	2	2	1
Handle Type	Lever, dual control	Lever, dual control	Dual levers for hot and cold	Dual levers for hot and cold	Lever, dual control
Hose Connection				1/2" BSP	
Mounting Type					
Deck Mounted	•	•	•		•
Deck Mounted with brass wall mounted handset holder				•	
Water Systems					
Low and high pressure systems	•	•	•	•	•
Features					
Brass body with zinc handles	•	•	•	•	•
Design	Soft Square	Soft Square	Soft Square	Soft Square	Round
Click clack waste included	•	•			•
Colour	Chrome	Chrome	Chrome	Chrome	Chrome
Flow Rate					
Open outlet mixed flow rate @ 3 bar pressure	4.82 l/pm	4.12 l/pm	47.17 l/pm	52.86 l/pm	4.48 l/pm
Approvals					
WRAS	2010081	2010081	2010082	2011091	1712128
Guarantee Period					
5 years	•	•	•	•	•

CENTRAL™

LARGE BASIN MIXER TAP	DECK MOUNTED BATH FILLER	BATH SHOWER MIXER	SINGLE BASIN MIXER TAP	LARGE BASIN MIXER TAP	DECK MOUNTED BATH FILLER	BATH SHOWER MIXER
0.2 bar	0.2 bar	0.2 bar	0.2 bar	0.2 bar	0.2 bar	0.2 bar
5 bar	5 bar	5 bar	5 bar	5 bar	5 bar	5 bar
•			•	•		
	•	•			•	•
	Hot/left, cold/right (as viewed from the front)	Hot/left, cold/right (as viewed from the front)			Hot/left, cold/right (as viewed from the front)	Hot/left, cold/right (as viewed from the front)
1	2	2	1	1	2	2
Lever, dual control	Dual levers for hot and cold	Dual levers for hot and cold	Lever, dual control	Lever, dual control	Dual levers for hot and cold	Dual levers for hot and cold
		1/2" BSP				1/2" BSP
•	•		•	•	•	
		•				•
•	•	•	•	•	•	•
•	•	•	•	•	•	•
Round	Round	Round	Rounded	Rounded	Rounded	Rounded
•			•	•		
Chrome	Chrome	Chrome	Chrome	Chrome	Chrome	Chrome
5.13 l/pm	38.98 l/pm	34.4 l/pm	4.84 l/pm	4.96 l/pm	59.16 l/pm	61.02 l/pm
1810125	1710209	1710223	2010081	1802141	1802139	1802140
•	•	•	•	•	•	•



SMART SHOWERS TECHNICAL INFORMATION

Quartz Touch™	84
Quartz Classic™	86
Quartz Blue™	90
iSystem™ Smart	92



AQUALISA

38



TAKE A CLOSER LOOK AT QUARTZ TOUCH™

FEATURES AND DIMENSIONS

KEY FEATURES

- 105mm adjustable head, 4 spray pattern Harmony handset
- Optional 230mm fixed head or bath fill to customise your experience
- Connectivity (Wifi, app, Hey Google, Alexa)
- Proximity sensor
- Online water management dashboard
- Flow control**
- Pre-set shower profiles
- Timer function in app
- Bath fill divert option
- Temperature ready indicator
- Aqualisa SmartValve™ eco-setting**
- Wireless remote option
- Full LED screen
- Thermostatic control
- Rub clean nozzles
- Dual outlet divert options
- Suitable for all water systems
- Optional exposed rail extension and corner fixing brackets available - see page 89
- Easily upgrade an exposed mixer shower with the Quartz Smart Retrofit Shower. See page 142.



ADJUSTABLE HEIGHT HEAD

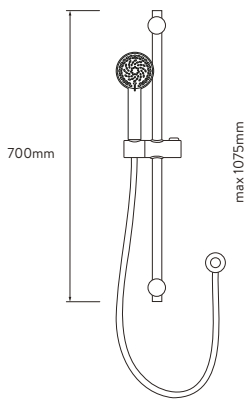

EXPOSED

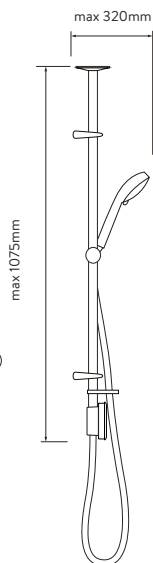

NON-PUMPED SMARTVALVE™

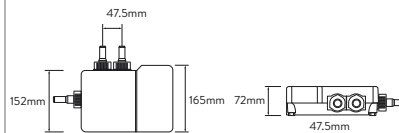

PUMPED SMARTVALVE™

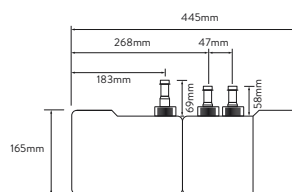

DIVERTER

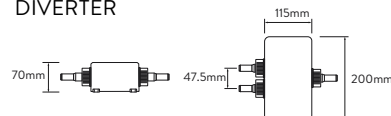

FIXED HEAD

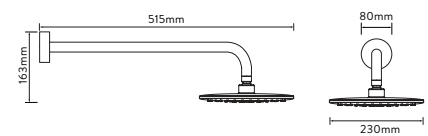

CONTROLLER

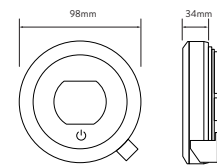

WIRELESS REMOTE

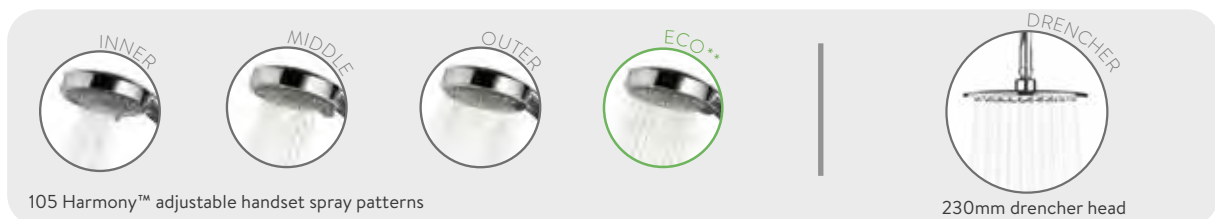
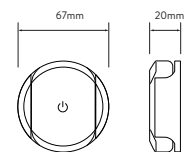

Product measurements for guidance only.



Quartz Touch™ concealed with adjustable head

HP/Combi
QZST.A1.BV.20
Gravity Pumped*
QZST.A2.BV.20



Quartz Touch™ concealed dual outlet with adjustable head and ceiling fixed drencher

HP/Combi
QZST.A1.BV.DVFC.20
Gravity Pumped*
QZST.A2.BV.DVFC.20



Quartz Touch™ concealed dual outlet with adjustable head and bath overflow filler

HP/Combi
QZST.A1.BV.DVBTX.20
Gravity Pumped*
QZST.A2.BV.DVBTX.20



Quartz Touch™ concealed dual outlet with adjustable head and wall fixed drencher

HP/Combi
QZST.A1.BV.DVFW.20
Gravity Pumped*
QZST.A2.BV.DVFW.20



Quartz Touch™ concealed with wall fixed drencher

HP/Combi
QZST.A1.BR.20
Gravity Pumped*
QZST.A2.BR.20



Quartz Touch™ exposed with adjustable head

HP/Combi
QZST.A1.EV.20
Gravity Pumped*
QZST.A2.EV.20



Quartz Touch™ exposed dual outlet with adjustable head and ceiling fixed drencher

HP/Combi
QZST.A1.EV.DVFC.20
Gravity Pumped*
QZST.A2.EV.DVFC.20



Quartz Touch™ dual outlet exposed with adjustable head and bath overflow filler

HP/Combi
QZST.A1.EV.DVBTX.20
Gravity Pumped*
QZST.A2.EV.DVBTX.20

Quartz Smart Retrofit Shower

HP/Combi
SST.A1.EV.21***
Gravity Pumped
SST.A2.EV.21***

Quartz Smart Retrofit Shower

HP/Combi
SST.A1.EV.DVFC.21***
Gravity Pumped
SST.A2.EV.DVFC.21***

*Gravity Pumped variant comes with integral pump.

**Feature may not operate on combination boiler systems.

***For more information on Quartz Smart Retrofit Showers see page 142.

TAKE A CLOSER LOOK AT QUARTZ CLASSIC™

FEATURES AND DIMENSIONS

KEY FEATURES

- 105mm adjustable head, 4 spray pattern Harmony handset
- Optional 230mm fixed head or bath fill to customise your experience
- Connectivity (Wifi, app, Hey Google, Alexa)
- Online water management dashboard
- Flow control**
- Timer function in app
- Bath fill divert option
- Single bath fill option
- Temperature ready indicator
- Aqualisa SmartValve™ eco-setting**
- Hard wired remote option
- Thermostatic control
- Rub clean nozzles
- Dual outlet divert options
- Suitable for all water systems
- Easily upgrade an exposed mixer shower with the Quartz Smart Retrofit Shower. See page 142.



ADJUSTABLE HEIGHT HEAD

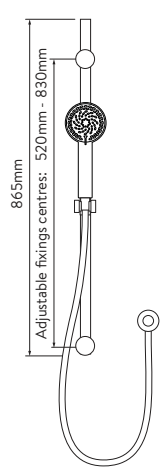

EXPOSED

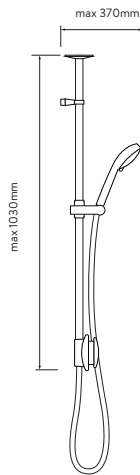

NON-PUMPED SMARTVALVE™

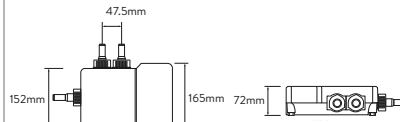

PUMPED SMARTVALVE™

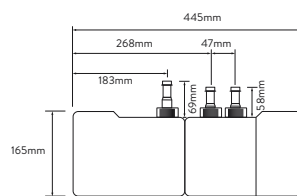

DIVERTER

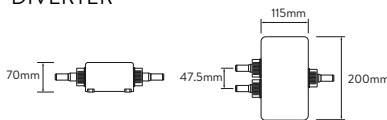

FIXED HEAD

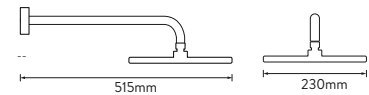

CONTROLLER

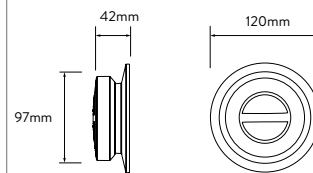

REMOTE CONTROL

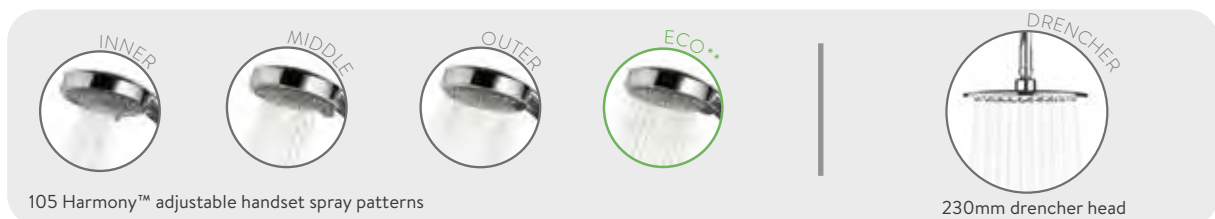
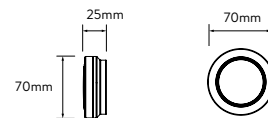

Product measurements for guidance only.



Quartz Classic™ concealed with adjustable head

HP/Combi
QZD.A1.BV.20
Gravity Pumped*
QZD.A2.BV.20



Quartz Classic™ dual outlet concealed with adjustable head and ceiling fixed drencher

HP/Combi
QZD.A1.BV.DVFC.20
Gravity Pumped*
QZD.A2.BV.DVFC.20



Quartz Classic™ concealed with adjustable head and bath overflow filler

HP/Combi
QZD.A1.BV.DVBTX.20
Gravity Pumped*
QZD.A2.BV.DVBTX.20



Quartz Classic™ concealed dual outlet with adjustable head and wall fixed drencher

HP/Combi
QZD.A1.BV.DVFW.20
Gravity Pumped*
QZD.A2.BV.DVFW.20



Quartz Classic™ concealed with wall fixed drencher

HP/Combi
QZD.A1.BR.20
Gravity Pumped*
QZD.A2.BR.20



Quartz Classic™ exposed with adjustable head

HP/Combi
QZD.A1.EV.20
Gravity Pumped*
QZD.A2.EV.20

Quartz Smart Retrofit Shower

HP/Combi
SSC.A1.EV.21***
Gravity Pumped
SSC.A2.EV.21***



Quartz Classic™ dual outlet exposed with adjustable head and ceiling fixed drencher

HP/Combi
QZD.A1.EV.DVFC.20
Gravity Pumped*
QZD.A2.EV.DVFC.20

Quartz Smart Retrofit Shower

HP/Combi
SSC.A1.EV.DVFC.21***
Gravity Pumped
SSC.A2.EV.DVFC.21***



Quartz Classic™ exposed dual outlet with adjustable head and bath overflow filler

HP/Combi
QZD.A1.EV.DVBTX.20
Gravity Pumped*
QZD.A2.EV.DVBTX.20

*Gravity Pumped variant comes with integral pump.

**Feature may not operate on combination boiler systems.

***For more information on Quartz Smart Retrofit Showers see page 142.

QUARTZ CLASSIC™ BATH FILL AND ACCESSORIES

FEATURES AND DIMENSIONS

KEY FEATURES

- Connectivity (Wifi, app, Hey Google, Alexa)
- Online water management dashboard
- Timer function in app
- Single bath fill option
- Temperature ready indicator
- Aqualisa SmartValve™ eco-setting**
- Hard wired remote option
- Thermostatic control
- Suitable for all water systems



CONTROLLER

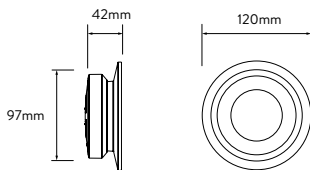

REMOTE CONTROL

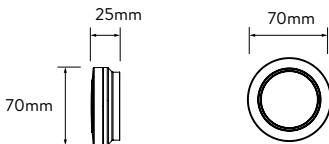

NON-PUMPED SMARTVALVE™

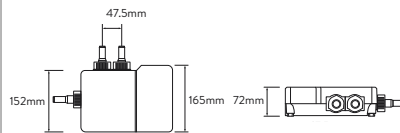

PUMPED SMARTVALVE™

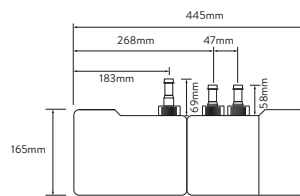

DIVERTER

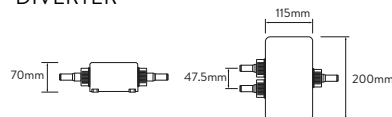

BATH OVERFLOW FILLER

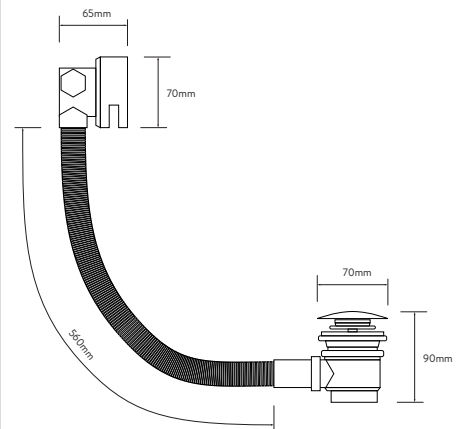

Product measurements for guidance only.



Quartz Classic™ bath overflow filler

HP/Combi
QZD.A1.BTX.20
Gravity Pumped*
QZD.A2.BTX.20



Quartz Classic™ wired remote control

Single Outlet
QZD.B3.DS.20



Quartz Classic™ wired remote control

Dual Outlet
QZD.B3.DVDS.20



Quartz™ concealed retrofit wall plate

To cover any existing damage to décor where the Quartz™ smart concealed is replacing an existing shower
QZD.B3.RWP.14



Quartz™ exposed rail corner fixing brackets

QZD.C3.EVCB.14



Quartz™ exposed rail extension (550mm)

For higher than normal ceilings when fitting Quartz™ smart exposed systems.
910920
Including rail 550mm, push-fit pipe joiner and exposed rail sleeve. Copper pipe not included.

*Gravity Pumped variant comes with integral pump.

**Feature may not operate on combination boiler systems.

TAKE A CLOSER LOOK AT QUARTZ BLUE™

FEATURES AND DIMENSIONS

KEY FEATURES

- 90mm adjustable head, 4 spray pattern Harmony handset
- Optional 200mm fixed head or bath fill to customise your experience
- Connectivity (Wifi, app, Google Home, Alexa)
- Online water management dashboard
- Timer function in app
- Bath fill divert option
- Temperature ready indicator
- Aqualisa SmartValve™ eco-setting**
- Thermostatic control
- Rub clean nozzles
- Dual outlet divert options
- All water systems
- Easily upgrade an exposed mixer shower with the Quartz Smart Retrofit Shower. See page 142.



ADJUSTABLE HEIGHT HEAD

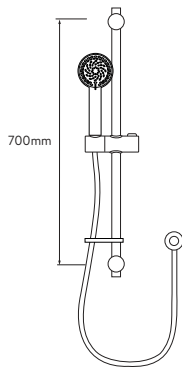

EXPOSED

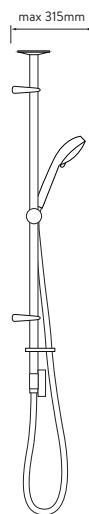

NON-PUMPED SMARTVALVE™

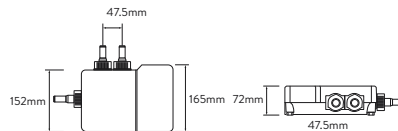

PUMPED SMARTVALVE™

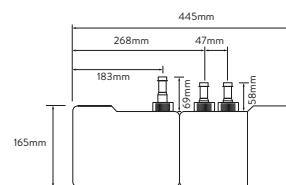

DIVERTER

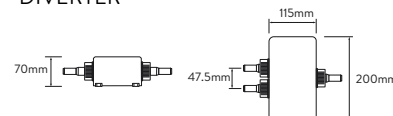

FIXED HEAD

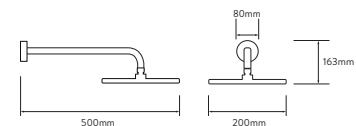

CONTROLLER

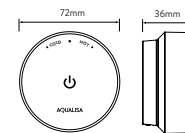

BATH OVERFLOW FILLER

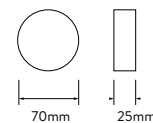

90mm Harmony™ adjustable handset spray patterns

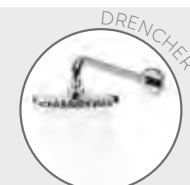

200mm drencher head

Product measurements for guidance only.



Quartz Blue™ concealed with adjustable head

HP/Combi
QZSB.A1.BV.20
Gravity Pumped*
QZSB.A2.BV.20



Quartz Blue™ dual outlet concealed with adjustable head and wall fixed drencher

HP/Combi
QZSB.A1.BV.DVFW.20
Gravity Pumped*
QZSB.A2.BV.DVFW.20



Quartz Blue™ dual outlet concealed with adjustable head and bath overflow filler

HP/Combi
QZSB.A1.BV.DVBTX.20
Gravity Pumped*
QZSB.A2.BV.DVBTX.20



Quartz Blue™ concealed with wall fixed drencher

HP/Combi
QZSB.A1.BR.20
Gravity Pumped*
QZSB.A2.BR.20



Quartz Blue™ exposed with adjustable head

HP/Combi
QZSB.A1.EV.20
Gravity Pumped*
QZSB.A2.EV.20

Quartz Smart Retrofit Shower

HP/Combi
SSB.A1.EV.21***
Gravity Pumped
SSB.A2.EV.21***



Quartz™ exposed rail corner fixing brackets

QZD.C3.EVCB.14



Quartz™ exposed rail extension (550mm)

For higher than normal ceilings when fitting Quartz™ smart exposed systems. 910920
Including rail 550mm, push-fit pipe joiner and exposed rail sleeve. Copper pipe not included.

*Gravity Pumped variant comes with integral pump.

**Feature may not operate on combination boiler systems.

***For more information on Quartz Smart Retrofit Showers see page 142.

TAKE A CLOSER LOOK AT iSYSTEM™ SMART

FEATURES AND DIMENSIONS

KEY FEATURES

- 100mm single mode adjustable head with easy clean nozzles
- Optional 230mm fixed head to customise your experience
- Pinch grip slider
- Connectivity (Wifi, app, Google Home, Alexa)
- Online water management dashboard
- Timer function in app
- Temperature ready indicator
- Aqualisa SmartValve™ eco-setting**
- Thermostatic control
- Dual outlet divert options
- Suitable for all water systems
- Optional exposed rail extension and corner fixing brackets available - see page 89



ADJUSTABLE HEIGHT HEAD

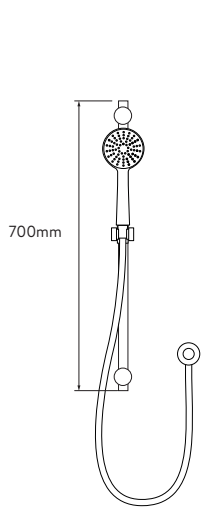

EXPOSED

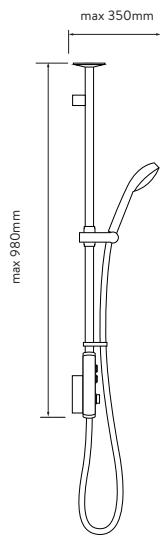

NON-PUMPED SMARTVALVE™

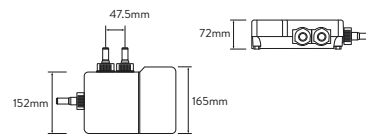

PUMPED SMARTVALVE™

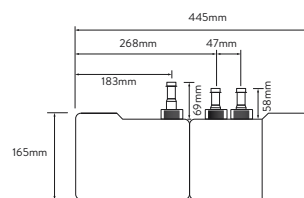

FIXED HEAD

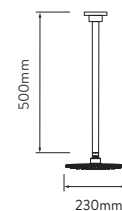
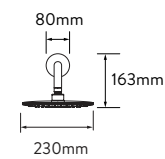
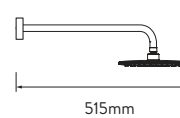

CONTROLLER

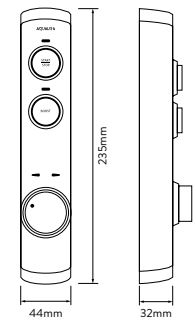

REMOTE

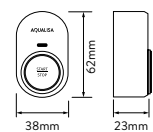

Product measurements for guidance only.



iSystem™ Smart concealed with adjustable head
 HP/Combi
 ISD.A1.BV.21
 Gravity Pumped*
 ISD.A2.BV.21



iSystem™ Smart exposed with adjustable head
 HP/Combi
 ISD.A1.EV.21
 Gravity Pumped*
 ISD.A2.EV.21



iSystem™ Smart concealed with wall fixed drencher
 HP/Combi
 ISD.A1.BFW.21
 Gravity Pumped*
 ISD.A2.BFW.21



iSystem™ Smart concealed with ceiling fixed drencher
 HP/Combi
 ISD.A1.BFC.21
 Gravity Pumped*
 ISD.A2.BFC.21



iSystem™ Smart dual outlet concealed with adjustable head and wall fixed drencher
 HP/Combi
 ISD.A1.BV.DVFW.21
 Gravity Pumped*
 ISD.A2.BV.DVFW.21



iSystem™ Smart dual outlet concealed with adjustable head and ceiling fixed drencher
 HP/Combi
 ISD.A1.BV.DVFC.21
 Gravity Pumped*
 ISD.A2.BV.DVFC.21



iSystem™ Smart dual outlet exposed with adjustable head and ceiling fixed drencher
 HP/Combi
 ISD.A1.EV.DVFC.21
 Gravity Pumped*
 ISD.A2.EV.DVFC.21



iSystem™ Smart remote control
 Single and divert wired
 ISD.B3.DS.14

*Gravity Pumped variant comes with integral pump.

**Feature may not operate on combination boiler systems.

MIXER & POWER SHOWERS TECHNICAL INFORMATION

Mixer Showers

Dream™ Concealed Mixer	96
Dream™ DL	100
Aspire™ DL	102
Aquavalve™ 609	104
Aquatique™	106
Midas™ 220	108
Midas™ 110	110
Midas™ 100	112
Siren™ SL	114
Aquavalve™ 700	116
Colt™	118
Aquarian™	120
Mach pumps	121

Power Showers

Aquastream™	122
-------------	-----

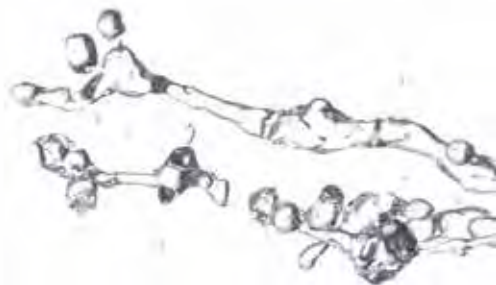



TAKE A CLOSER LOOK AT DREAM™ CONCEALED THERMOSTATIC MIXERS

ROUND - FEATURES AND DIMENSIONS

KEY FEATURES

- 105mm Harmony adjustable handset with soft, rub clean nozzles
- 250mm fixed shower head
- Chrome plated pinch grip slider
- 1.5m smooth hose
- Thermostatic control for safe water temperature
- Metal controls
- Push fit metal wall plate 2mm thickness
- Bath overflow filler option



ADJUSTABLE HEIGHT HEAD

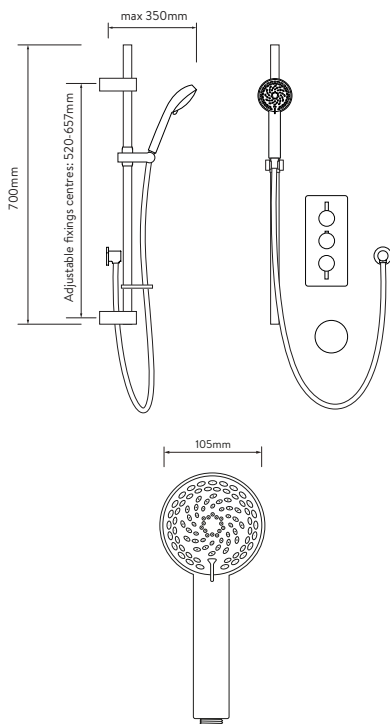

DRENCHER HEAD

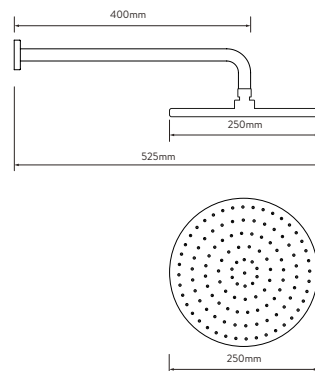

HAND SHOWER AND HOLDER

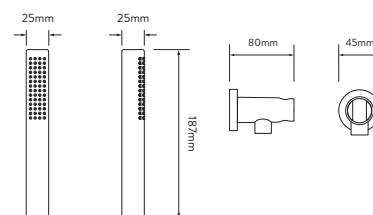

VALVES

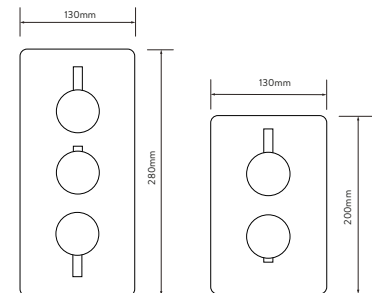

BATH OVERFLOW FILLER

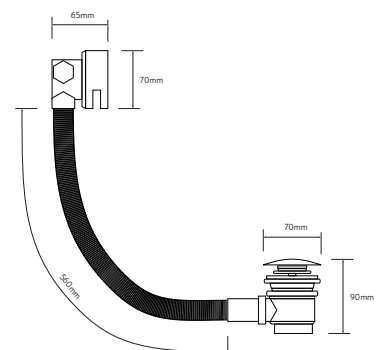

Product measurements for guidance only.



Dream™ concealed mixer shower with adjustable head
DRMDCV1.AD.RND



Dream™ concealed mixer shower with wall fixed drencher
DRMDCV1.FW.RND



Dream™ concealed mixer shower with adjustable head and wall fixed drencher
DRMDCV2.ADFW.RND



Dream™ concealed mixer shower with wall fixed drencher and hand shower
DRMDCV2.HSFW.RND



Dream™ concealed mixer shower with adjustable head and bath overflow filler
DRMDCV2.ADBTX.RND



Dream™ concealed mixer shower with adjustable head, wall fixed drencher and bath overflow filler
DRMDCV3.ADFWBTX.RND

SHOWER HEADS

Dream™ concealed mixer showers feature:

- 250mm drencher head
- 105mm Harmony™ head
- 25mm hand shower wand



TAKE A CLOSER LOOK AT DREAM™ CONCEALED THERMOSTATIC MIXERS SQUARE - FEATURES AND DIMENSIONS

KEY FEATURES

- 109mm multimode adjustable handset with soft, rub clean nozzles
- 250mm fixed shower head
- Chrome plated quarter turn handset holder
- 1.5m smooth hose
- Thermostatic control for safe water temperature
- Metal controls
- Push fit metal wall plate 2mm thickness
- Bath overflow filler option



ADJUSTABLE HEIGHT HEAD

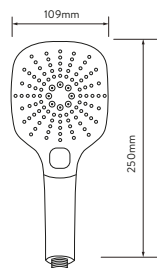
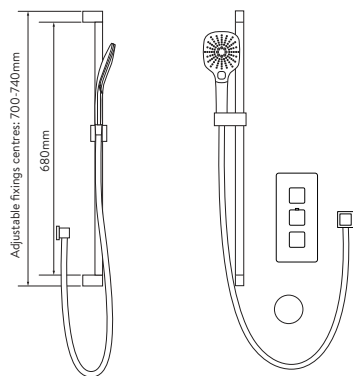

DRENCHER HEAD

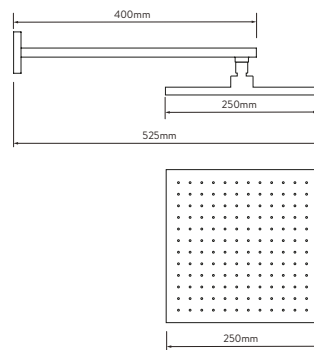

HAND SHOWER AND HOLDER

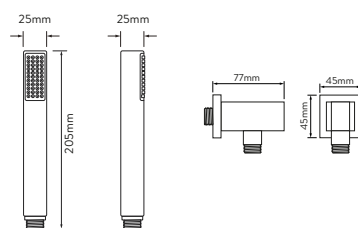

VALVES

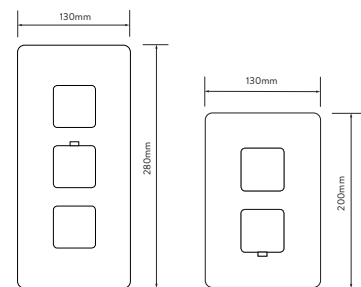

BATH OVERFLOW FILLER

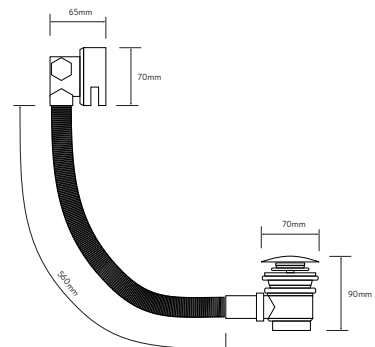

Product measurements for guidance only.



Dream™ concealed mixer shower with adjustable head
DRMDCV1.AD.SQR



Dream™ concealed mixer shower with wall fixed drencher
DRMDCV1.FW.SQR



Dream™ concealed mixer shower with adjustable head and wall fixed drencher
DRMDCV2.ADFW.SQR



Dream™ concealed mixer shower with wall fixed drencher and hand shower
DRMDCV2.HSFW.SQR



Dream™ concealed mixer shower with adjustable head and bath overflow filler
DRMDCV2.ADBTX.SQR



Dream™ concealed mixer shower with adjustable head, wall fixed drencher and bath overflow filler
DRMDCV3.ADFWBTX.SQR

TAKE A CLOSER LOOK AT DREAM™ DL

FEATURES AND DIMENSIONS

KEY FEATURES

- Harmony Handset with 4 spray patterns
- Easy clean nozzles
- Easy click spray selector
- Pinch grip slider
- Chrome plated 1.5m metal hose
- Temperature override button
- Gel hanger



ADJUSTABLE HEIGHT HEAD

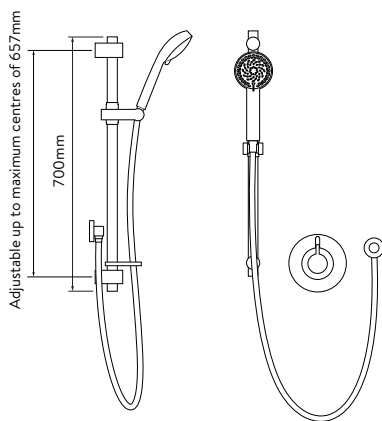

FIXED HEAD

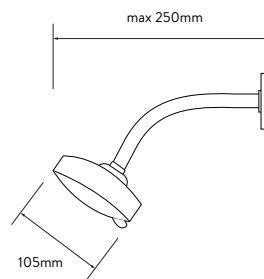

CONCEALED VALVE

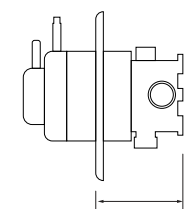
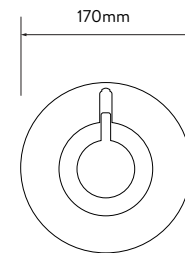

60mm min, 100mm max
from back face of valve to
finish / tiled wall surface.
(10mm allowance for tiles)

Product measurements for guidance only.



Dream™ DL concealed mixer shower with adjustable head
DRM001CA



Dream™ DL concealed mixer shower with wall fixed head
DRM001CF

SHOWER HEADS

Dream™ DL mixer showers feature:
105mm fixed head
105mm Harmony™ head



105mm fixed head



105mm Harmony™ head

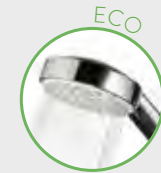
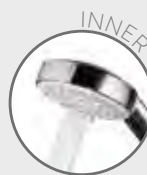

TAKE A CLOSER LOOK AT ASPIRE™ DL

FEATURES AND DIMENSIONS

KEY FEATURES

- Harmony Handset with 4 spray patterns
- Easy clean nozzles
- Easy click spray selector
- Pinch grip slider
- Chrome plated 1.5m metal hose
- Gel hanger



ADJUSTABLE HEIGHT HEAD

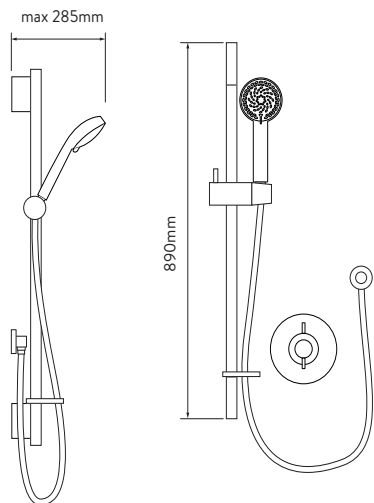

FIXED HEAD

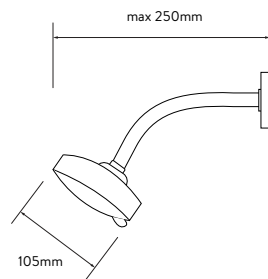

CONCEALED VALVE

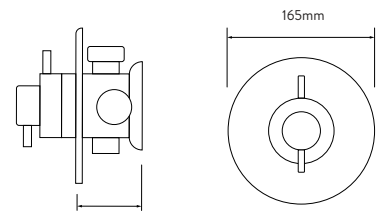

65mm min, 70mm max from back face of valve to finished / tiled wall surface (10mm allowance for tiles)

EXPOSED VALVE

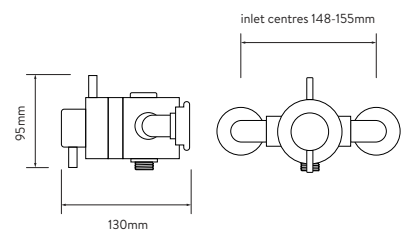

Product measurements for guidance only.



Aspire™ DL concealed mixer shower with adjustable head
ASP001CA



Aspire™ DL concealed mixer shower with wall fixed head
ASP001CF



Aspire™ DL exposed mixer shower with adjustable head
ASP001EA

SHOWER HEADS

Aspire™ DL mixer showers feature:
105mm fixed head
105mm Harmony™ head



105mm fixed head



105mm Harmony™ head

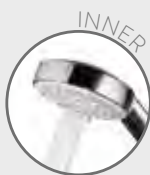

INNER



MIDDLE



OUTER



ECO

TAKE A CLOSER LOOK AT AQUAVALVE™ 609

FEATURES AND DIMENSIONS

KEY FEATURES

- Varispray or Turbostream handset with 3 spray pattern
- Choice of fixed or adjustable head
- Fixed tilt head
- Easy clean nozzles
- Rotating spray selector
- Pinch grip slider
- Chrome plated 1.5m metal hose
- Temperature override button
- Soap dish



ADJUSTABLE HEIGHT HEAD

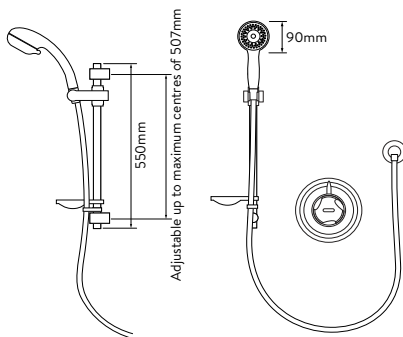

FIXED HEAD

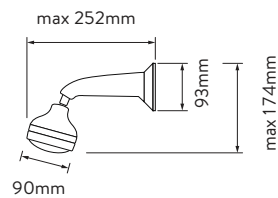

CONCEALED VALVE

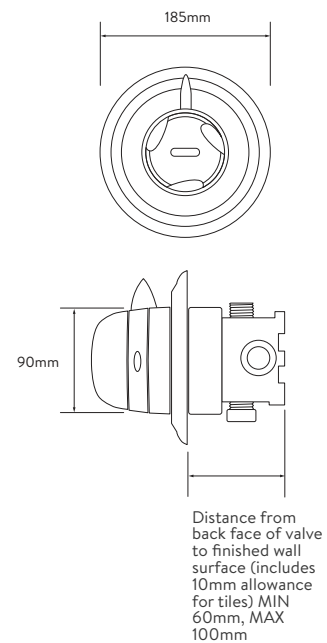

Product measurements for guidance only.



CHROME

Aqua valve™ 609 Thermo concealed valve with adjustable or fixed head – chrome

Concealed valve C609.01T

Adjustable Varispray head 99.40.01

Adjustable Turbostream head 99.20.01

Fixed Varispray head 99.50.01

Fixed Turbostream head 99.30.01



WHITE FINISH

Aqua valve™ 609 Thermo concealed valve with adjustable or fixed head – white

Concealed valve C609.20T

Adjustable Varispray head 99.40.20

Fixed Varispray head: 99.50.20

VARISPRAY SHOWER HEADS

Aqua valve™ 609 mixer features 90mm Varispray Adjustable shower head.



90mm Varispray fixed head

90mm Varispray shower head spray patterns



TURBOSTREAM SHOWER HEADS*

Aqua valve™ 609 mixer features 90mm Turbostream Adjustable shower head.



90mm Turbostream fixed head

90mm Turbostream shower head spray patterns



*Not suitable for low pressure or combi boiler systems

TAKE A CLOSER LOOK AT AQUATIQUE™

FEATURES AND DIMENSIONS

KEY FEATURES

- 8" or 5" tilt drencher head available
- Brass bodied valve
- Victorian style adjustable head available
- Adjustable height slider
- Ceramic handle



ADJUSTABLE HEIGHT HEAD

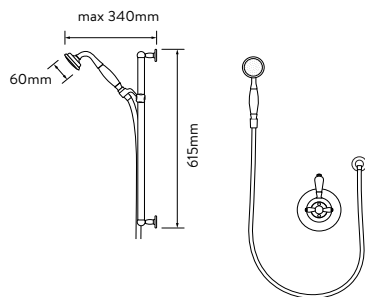

DRENCHER HEAD

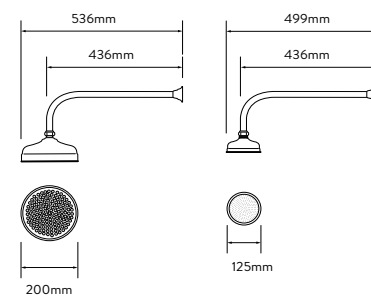

CONCEALED VALVE

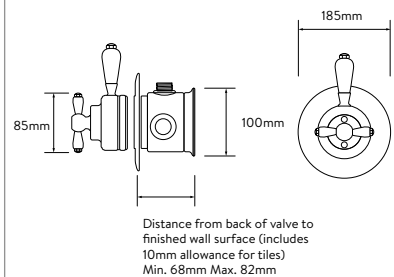

EXPOSED VALVE

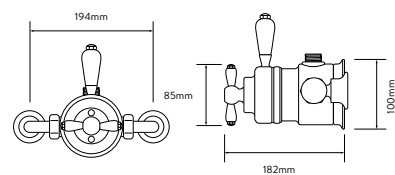

SHOWER HEADS

Aquatique™ shower features

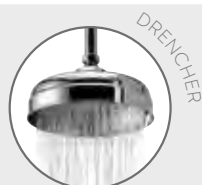

5" drencher head spray pattern

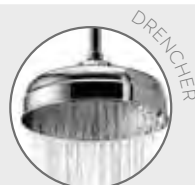

8" drencher head spray pattern



60mm adjustable head

Product measurements for guidance only.



Aquatique™ Thermo concealed mixer shower with fixed 8" drencher head – chrome

Valve: 500.00.01
Head: 580.01



Aquatique™ Thermo concealed mixer shower with fixed 5" drencher head – chrome

Valve: 500.00.01
Head: 550.01



Aquatique™ Thermo concealed mixer shower with adjustable head – chrome

Valve: 500.00.01
Head: 560.01



Aquatique™ Thermo exposed mixer shower with adjustable head – chrome

Valve: 500.10.01
Head: 561.01



Aquatique™ Thermo exposed mixer shower with fixed 8" drencher head – chrome

Valve: 500.10.01
Head: 581.01



Aquatique™ Thermo exposed mixer shower with fixed 5" drencher head – chrome

Valve: 500.10.01
Head: 551.01



Also available in gold finish

Concealed valve: 500.00.04

Exposed valve: 500.10.04

Concealed fixed 5" drencher head: 550.04

Concealed fixed 8" drencher head: 580.04

Exposed fixed 5" drencher head: 551.04

Exposed fixed 8" drencher head: 581.04

Concealed adjustable head: 560.04

Exposed adjustable head: 561.04

TAKE A CLOSER LOOK AT MIDAS™ 220

FEATURES AND DIMENSIONS

KEY FEATURES

- 105mm Harmony handset with 4 spray patterns
- 230mm fixed head
- Smooth chrome hose
- Easy click spray selector
- Easy clean nozzles
- Pinch grip slider
- Brass valve
- Temperature override button
- Safe touch
- Gel hanger

BAR VALVE FIXING KIT INCLUDED
(WITH SHOWER & SHOWER COLUMN)

* Pipe centres can be adjusted between 130mm -170mm using the adjustable elbows supplied



BAR MIXER SHOWER WITH ADJUSTABLE HEAD

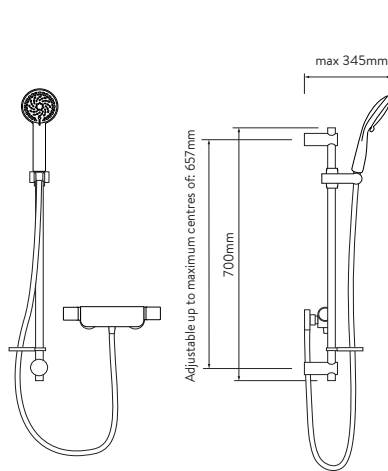

BAR MIXER VALVE

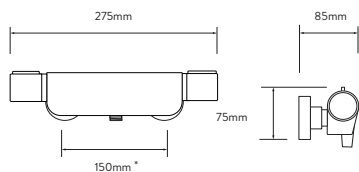

SHOWER COLUMN MIXER WITH ADJUSTABLE HEAD

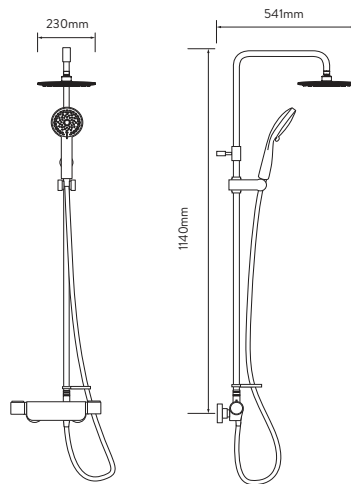

BAR MIXER VALVE

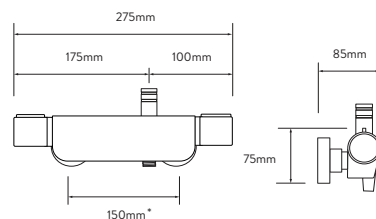

BATH SHOWER MIXER WITH ADJUSTABLE HEAD

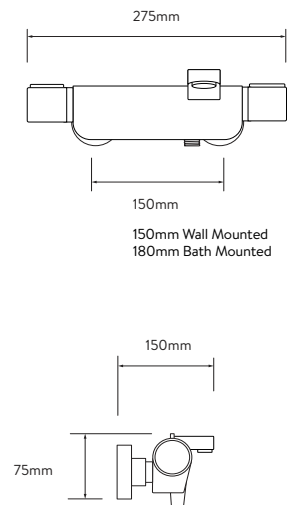

Product measurements for guidance only.



Midas™ 220 bar mixer shower with adjustable head
All Systems
MD220S



Midas™ 220 shower column mixer with adjustable head* and fixed head
HP/Combi
MD220SC



Midas™ 220 bath shower mixer with adjustable head*
HP/Combi
MD220BSM
Plus wall mount fitting kit
525301

SHOWER HEADS

Midas™ 220 shower features:
105mm Harmony™ head

Spray patterns

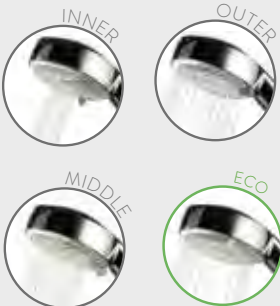

*If on Gravity system, use with a universal pump if working head distance is less than 1.25m.

TAKE A CLOSER LOOK AT MIDAS™ 110

FEATURES AND DIMENSIONS

KEY FEATURES

- 105mm Harmony Handset with 4 spray patterns
- 215mm fixed head
- Chrome plated metal hose
- Easy clean nozzles
- Easy click spray selector
- Pinch grip slider
- Retro fit rail brackets
- Brass valve
- Temperature override button
- Safe touch
- Gel hanger

BAR VALVE FIXING KIT INCLUDED
(WITH SHOWER & SHOWER COLUMN)

* Pipe centres can be adjusted between 130mm
-170mm using the adjustable elbows supplied



BAR MIXER SHOWER WITH ADJUSTABLE HEAD

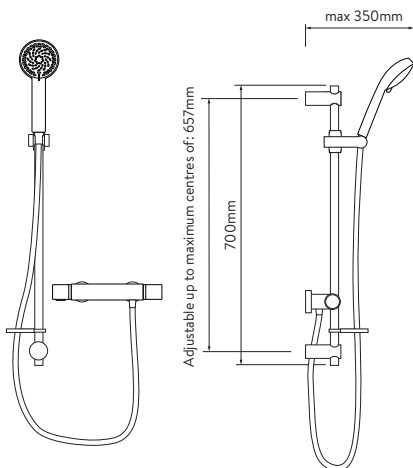

SHOWER COLUMN MIXER WITH ADJUSTABLE HEAD

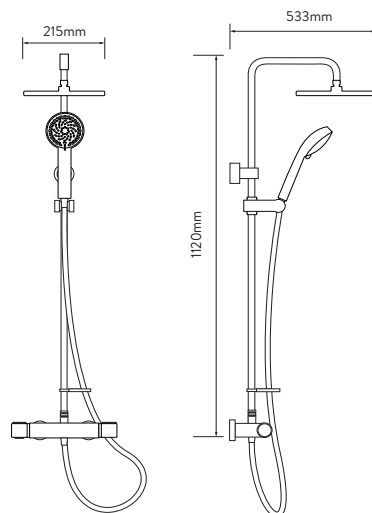

BATH SHOWER MIXER WITH ADJUSTABLE HEAD

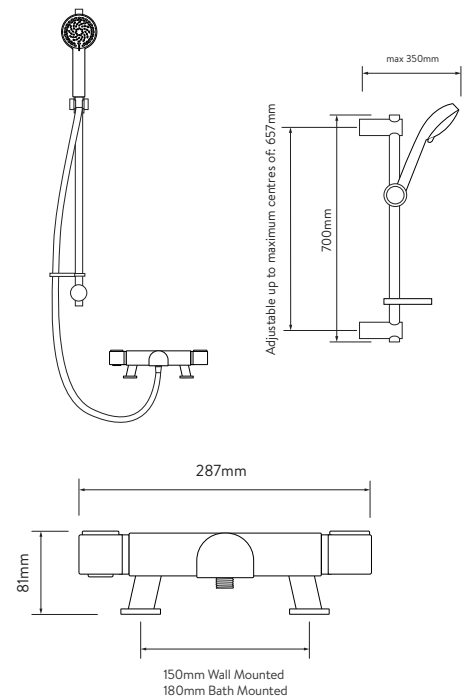

Product measurements for guidance only.



Midas™ 110 bar mixer shower with adjustable head

MD110S



Midas™ 110 shower column mixer with adjustable head* and fixed head

HP/Combi
MD110SC



Midas™ 110 bath shower mixer with adjustable head*

HP/Combi
MD110BSM

Plus wall mount fitting kit
525301

SHOWER HEADS

Midas™ 110 shower features:
105mm Harmony™ head



Spray patterns



If on Gravity system, use with a universal pump if working head distance is less than 1.25m.

TAKE A CLOSER LOOK AT MIDAS™ 100

FEATURES AND DIMENSIONS

KEY FEATURES

- 90mm Harmony Handset with 4 spray patterns
- Chrome hose – 1.25m (shower) 1.75m (bath shower mixer)
- Easy clean nozzles
- Adjustable height slider
- Easy click spray selector
- Pinch grip slider
- Temperature override button
- Safe touch
- Gel hanger

BAR VALVE FIXING KIT INCLUDED
(WITH SHOWER & SHOWER COLUMN)

* Pipe centres can be adjusted between
130mm -170mm using the adjustable
elbows supplied

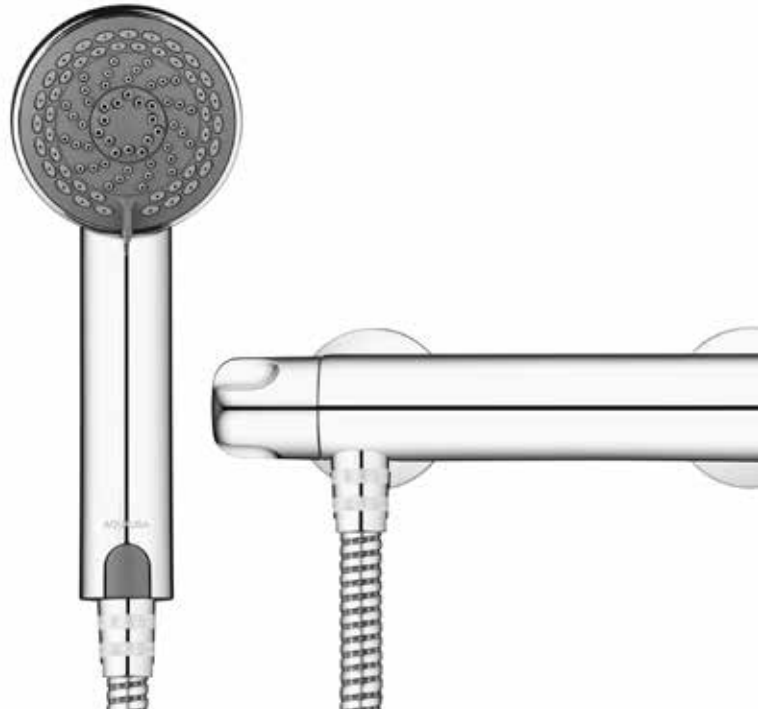

CONCEALED BAR MIXER SHOWER WITH ADJUSTABLE HEAD

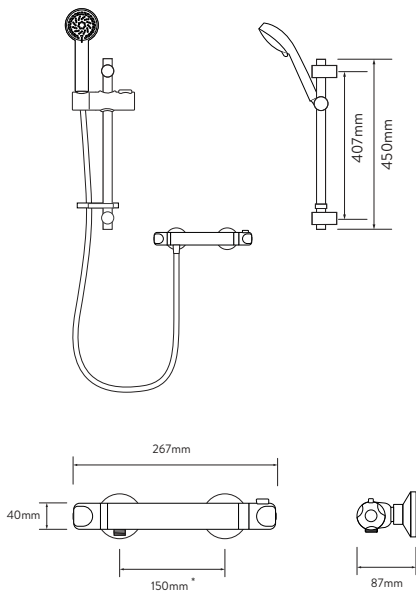

BATH SHOWER MIXER

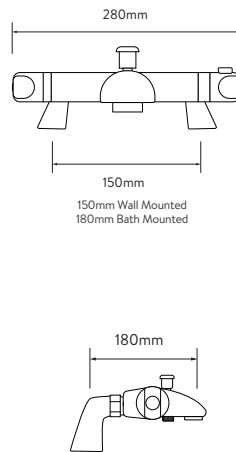

Product measurements for guidance only.



Easy fit bracket

Midas™ 100 bar mixer shower with adjustable head
MD100BAR

Midas™ 100 bar mixer shower with adjustable head and 'easy fit' bracket
MD100EBAR



Midas™ 100 bath shower mixer with adjustable head
MD100BSM
Plus wall mount fitting kit 525301

SHOWER HEADS

Midas™ 110 shower feature: 90mm Harmony™ head



Spray patterns



MIDAS ACCESSORIES



150mm centres

Concealed fixing bracket
MD300EFB



Bar valve fixing kit
BAR001FIX



MD300BMT

Midas™ basin monobloc tap
HP/Combi
MD300BMT

Midas™ 6lpm basin tap aerator
479104

Midas™ 2lpm basin tap jet spray
479105



479101



910056



479102



479103

Midas™ 12lpm flow regulator and housing
479101

Midas™ 9lpm flow regulator and housing
479102

Midas™ 8lpm flow regulator and housing
910056

Midas™ 6lpm flow regulator and housing
479103



Chrome exposed pipe fittings (pair)
479106
Not suitable for fixed head bar valves



Wall mount fitting kit
525301

TAKE A CLOSER LOOK AT SIREN™ SL

FEATURES AND DIMENSIONS

KEY FEATURES

- 90mm Harmony Handset with 4 spray patterns
- Chrome plated 1.5m metal hose
- Easy clean nozzles
- Adjustable height slider
- Easy click spray selector
- Gel Hanger



MIXER SHOWER WITH ADJUSTABLE HEAD

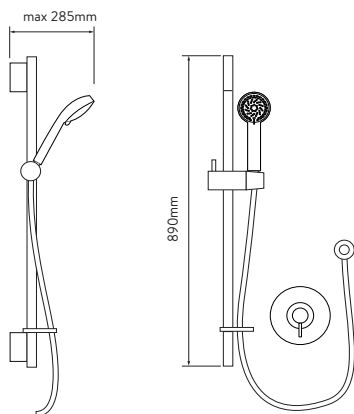

CONCEALED VALVE

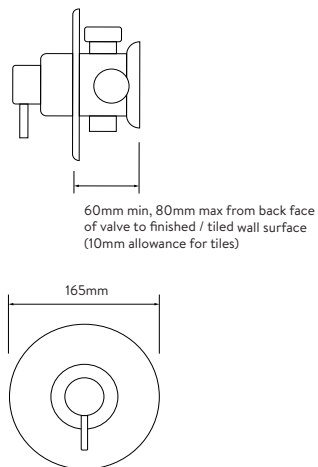

EXPOSED VALVE

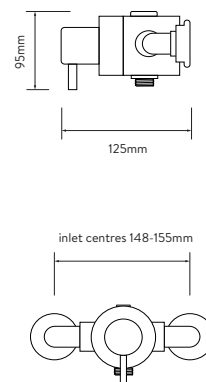

Product measurements for guidance only.



Siren™ SL concealed mixer shower with adjustable head
SRN001CA



Siren™ SL exposed mixer shower with adjustable head
SRN001EA

SHOWER HEADS

Siren™ SL
shower features: 90mm Harmony™ head



Spray patterns



TAKE A CLOSER LOOK AT AQUAVALVE™ 700

FEATURES AND DIMENSIONS

KEY FEATURES

- Varispray or Turbostream handset with 3 spray pattern
- Choice of fixed tilt head or adjustable head
- Chrome plated 1.5m metal hose
- Easy clean nozzles
- Hose restraint
- Soap dish



CONCEALED MIXER SHOWER WITH ADJUSTABLE HEAD

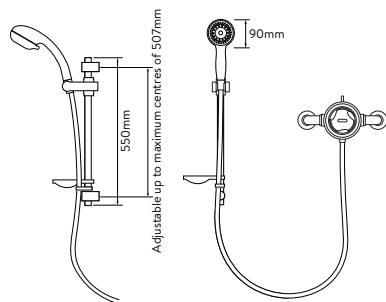

CONCEALED VALVE

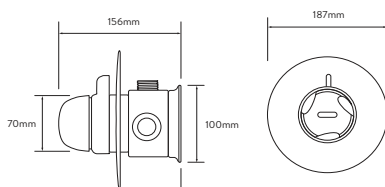

FIXED HEAD

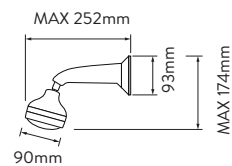

EXPOSED VALVE

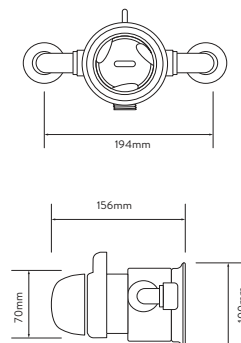

Product measurements for guidance only.



Aquavalve™ 700 Thermo concealed mixer shower with adjustable head – chrome

Valve
700.50.01

Varispray head
99.40.01

Turbostream head
99.20.01



Aquavalve™ 700 Thermo concealed mixer shower with fixed head – chrome

Valve
700.50.01

Varispray head
99.50.01

Turbostream head
99.30.01



Aquavalve™ 700 Thermo exposed mixer shower with adjustable head – chrome

Valve
700.51.01

Varispray head
99.40.01

Turbostream head
99.20.01

VARISPRAY SHOWER HEADS

Aquavalve™ 700 mixer features 90mm Varispray Adjustable shower head.



90mm Varispray fixed head

90mm Varispray shower head spray patterns

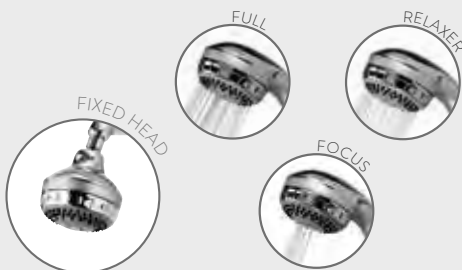

TURBOSTREAM SHOWER HEADS*

Aquavalve™ 700 mixer features 90mm Turbostream Adjustable shower head.



90mm Turbostream fixed head

90mm Turbostream shower head spray patterns



*Not suitable for low pressure or combi boiler systems

TAKE A CLOSER LOOK AT COLT™

FEATURES AND DIMENSIONS

KEY FEATURES

- 90mm Harmony Handset with 4 spray patterns
- Chrome plated 1.5m metal hose
- Easy clean nozzles
- Easy click spray selector
- Pinch grip slider
- Temperature override button
- Gel hanger
- Soap dish



CONCEALED MIXER SHOWER WITH ADJUSTABLE HEAD

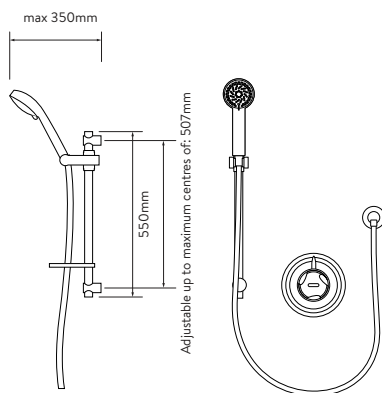

EXPOSED MIXER SHOWER WITH ADJUSTABLE HEAD

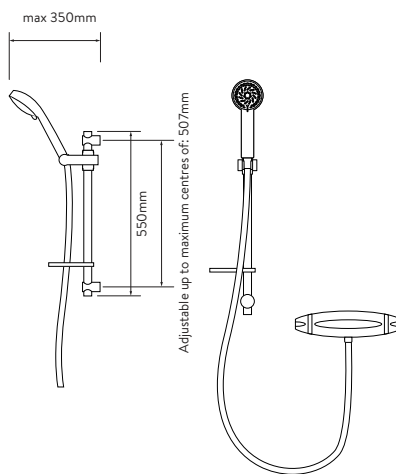

CONCEALED VALVE

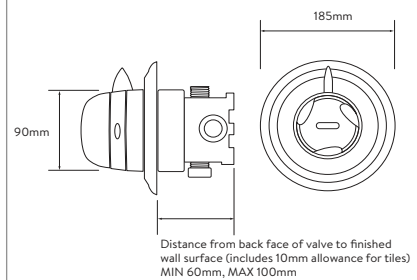

EXPOSED VALVE

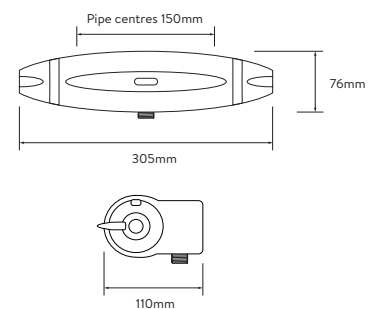

Product measurements for guidance only.



Colt™ concealed mixer shower with adjustable head
COLT001CA



Colt™ exposed mixer shower with adjustable head
COLT001EA

SHOWER HEADS

Colt™ shower features: 90mm Harmony™ head



Spray patterns



TAKE A CLOSER LOOK AT AQUARIAN™

FEATURES AND DIMENSIONS

KEY FEATURES

- 90mm Varispray handset with 3 spray patterns
- Chrome plated 1.5m metal hose
- A choice of fixed 'Tilt' head or adjustable head
- Easy clean nozzles
- Pinch grip slider
- Hose restraint
- Temperature override button
- Soap dish



EXPOSED MIXER SHOWER WITH ADJUSTABLE HEAD

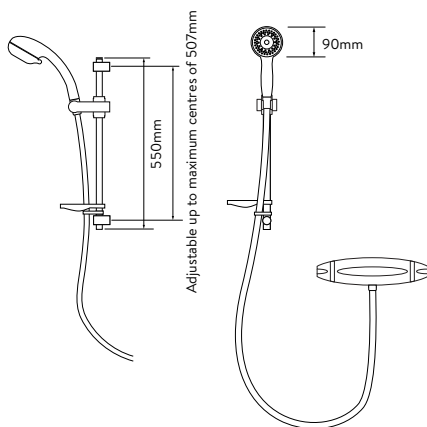

FIXED HEAD

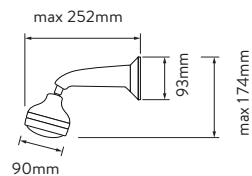

EXPOSED VALVE

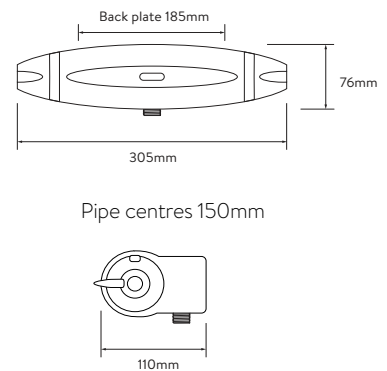

Product measurements for guidance only.



CHROME

Aquarian™ Thermo exposed valve with adjustable or fixed head – chrome
 Exposed valve
 E99.01T

Adjustable Varispray head
 99.40.01

Fixed Varispray head
 99.50.01

Fixed Turbostream head
 99.30.01



WHITE FINISH

Aquarian™ Thermo exposed valve with adjustable or fixed head – white
 Exposed valve
 E99.20T

Adjustable Varispray head
 99.40.20

Fixed Varispray head
 99.50.20

Fixed Turbostream head
 99.30.20

MACH SHOWER PUMPS

Suitable for use with mixer showers and single outlet Smart showers on Gravity water systems only. Not suitable for use with Aquastream™ Thermo, integral pumped Smart showers and Smart dual outlet showers on Gravity water systems.



Mach 1.2 Bar twin ended shower pump
 MC0120



Mach 2.5 Bar twin ended shower pump
 MC0250



Mach 3.4 Bar twin ended shower pump
 MC0340

TAKE A CLOSER LOOK AT AQUASTREAM™

FEATURES AND DIMENSIONS

KEY FEATURES

- 90mm Harmony Handset with 4 spray patterns
- Chrome plated 1.5m metal hose on chrome and white/chrome models. Smooth white hose on white only model
- Easy click spray connector
- Easy clean nozzles
- Pinch grip slider
- On/off flow control – two flow settings with intergraded booster pump
- Gel hanger



POWER SHOWER WITH
ADJUSTABLE HEAD

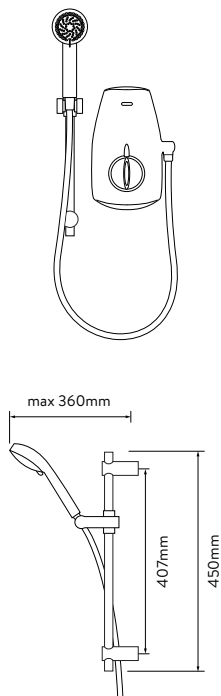

ADJUSTABLE HEAD

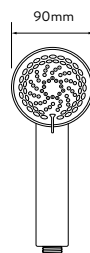

POWER SHOWER BODY

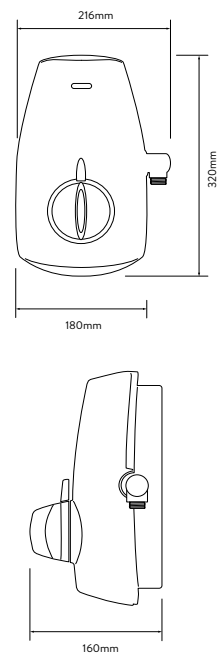

Product measurements for guidance only.



CHROME



Aquastream™ power shower with adjustable head
813.40.01



WHITE FINISH



Aquastream™ power shower with adjustable head
813.40.20



WHITE CHROME



Aquastream™ power shower with adjustable head
813.40.21

SHOWER HEADS

Aquastream™ power shower features:
90mm Harmony™ head



Spray patterns

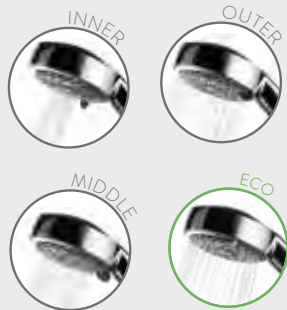



ELECTRIC SHOWERS TECHNICAL INFORMATION

Lumi™ Electric	126
Quartz™ Electric	128



AQUALISA

GOLD HO

G

TAKE A CLOSER LOOK AT LUMI™ ELECTRIC

FEATURES AND DIMENSIONS

KEY FEATURES

- 105mm Harmony electric handset with 5 spray settings
- Easy click spray connector
- Easy clean nozzles
- Pinch grip slider
- Deluxe 1.25m chrome hose
- Sensory touch start/stop control
- Mirrored glass fascia
- Illuminated panel

SAFETY

- Phased shutdown
- Unique Over Temperature Protection
- Safety backed glass



ELECTRIC SHOWER WITH ADJUSTABLE HEAD

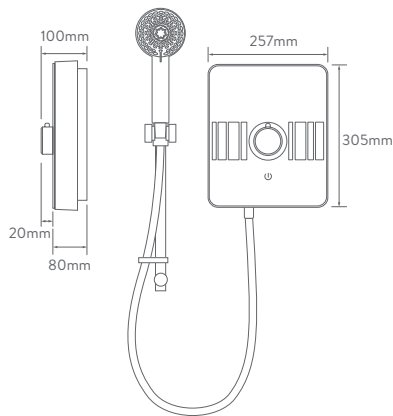

ADJUSTABLE HEAD

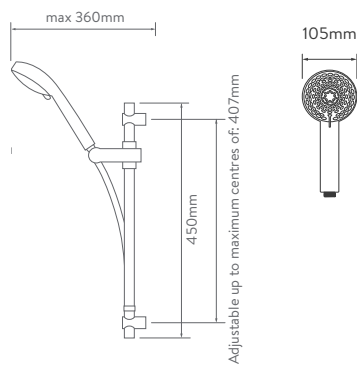

CONNECTIONS

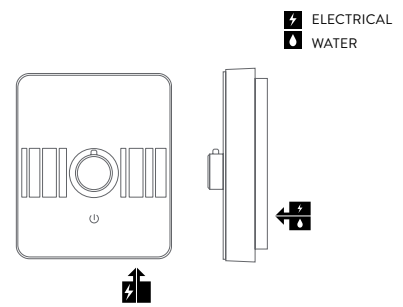

15mm compression water connection

Product measurements for guidance only.



Aqualisa Lumi™ Electric with adjustable head - chrome

- 8.5kW LME8501
- 9.5kW LME9501
- 10.5kW LME10501



Aqualisa Lumi™ Electric with adjustable head - white/chrome

- 8.5kW LME8521
- 9.5kW LME9521
- 10.5kW LME10521



SHOWER HEADS

Lumi™ Electric shower features:
105mm Harmony™ Electric head

Spray patterns



TAKE A CLOSER LOOK AT QUARTZ™ ELECTRIC

FEATURES AND DIMENSIONS

KEY FEATURES

- 105mm Harmony electric handset with 5 spray settings
- Easy click spray connector
- Easy clean nozzles
- Anti-twist hose connector
- Stainless steel 1.2m hose
- Illuminated one touch start/stop control

SAFETY

- Phased shutdown
- Unique Over Temperature Protection



ELECTRIC SHOWER WITH ADJUSTABLE HEAD

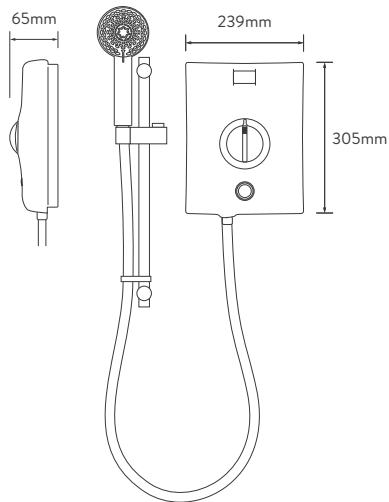

ADJUSTABLE HEAD

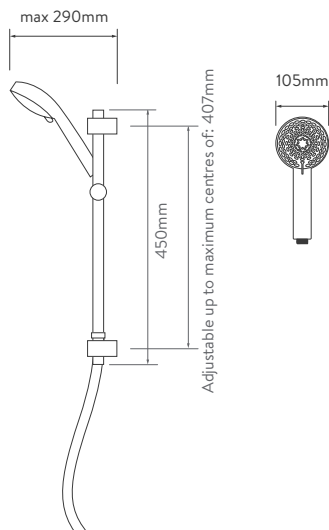

CONNECTIONS

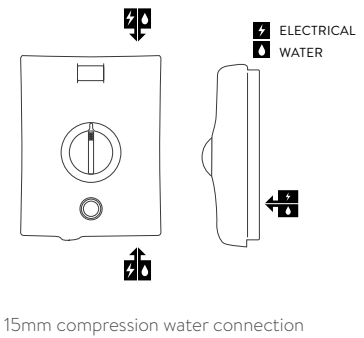

Product measurements for guidance only.



Quartz™ Electric shower with adjustable head - graphite

8.5kW QZE8511
9.5kW QZE9511
10.5kW QZE10511



Quartz™ Electric shower with adjustable head - chrome

8.5kW QZE8501
9.5kW QZE9501
10.5kW QZE10501



Quartz™ Electric shower with adjustable head - white/chrome

8.5kW QZE8521
9.5kW QZE9521



SHOWER HEADS

Quartz™ Electric shower features:
105mm Harmony™ Electric head

Spray patterns

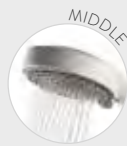



TAPS TECHNICAL INFORMATION

Downtown™	132
Uptown™	134
Central™	136



TAKE A CLOSER LOOK AT DOWNTOWN™

FEATURES AND DIMENSIONS

KEY FEATURES

- Angular soft square lever
- Aqualisa branded
- LP/HP systems
- Brass body with zinc handles
- Polished chrome finish colour
- 5 year guarantee
- WRAS approved



SMALL BASIN MIXER TAP

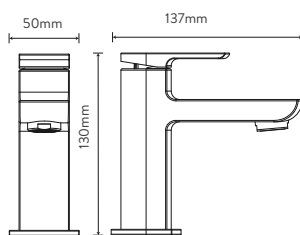

DECK MOUNTED BATH FILLER

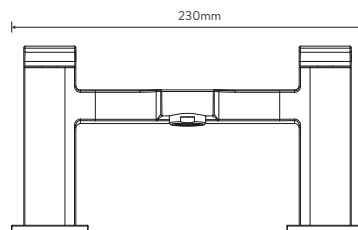

BATH SHOWER MIXER

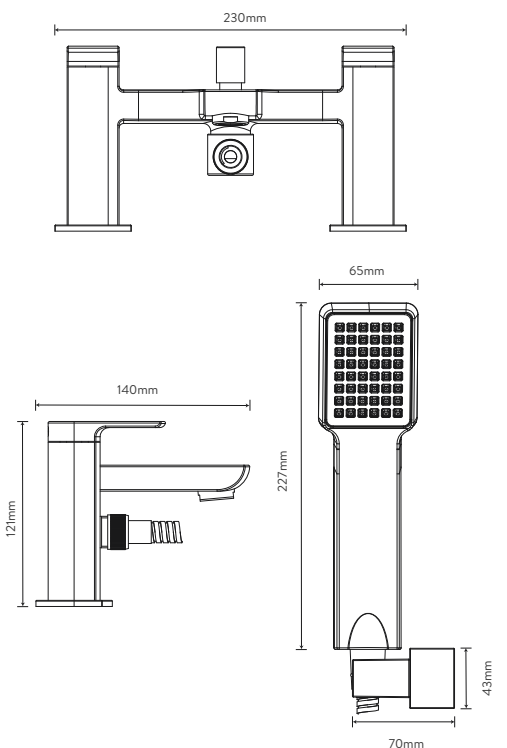

LARGE BASIN MIXER TAP

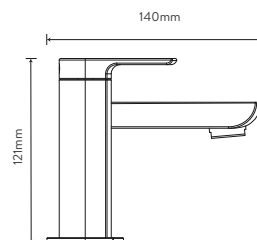
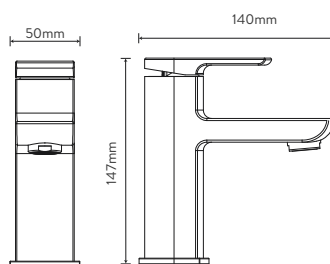

Product measurements for guidance only.



**Downtown™ small basin
mixer tap**
DT.SPT.CH



**Downtown™ large basin
mixer tap**
DT.LPT.CH



**Downtown™ deck mounted
bath filler**
DT.DBF.CH



**Downtown™ bath shower
mixer**
DT.BSMT.CH

TAKE A CLOSER LOOK AT UPTOWN™

FEATURES AND DIMENSIONS

KEY FEATURES

- Pin lever
- Aqualisa branded
- LP/HP systems
- Brass body with zinc handles
- Polished chrome finish colour
- 5 year guarantee
- WRAS approved



SMALL BASIN MIXER TAP

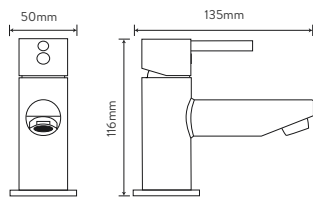

LARGE BASIN MIXER TAP

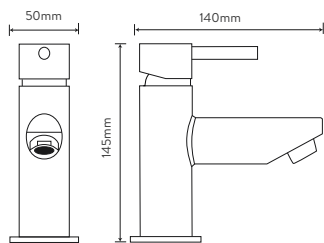

DECK MOUNTED BATH FILLER

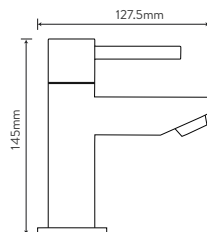
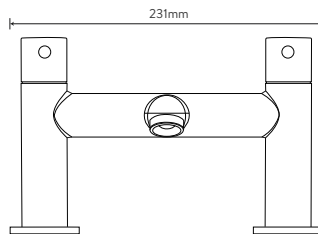

BATH SHOWER MIXER

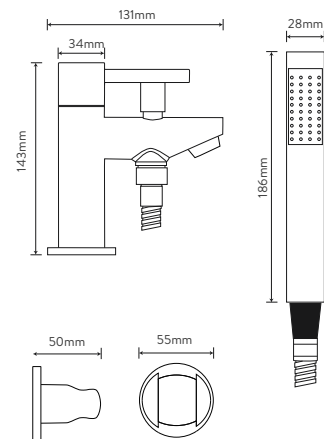
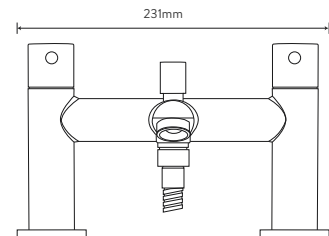

Product measurements for guidance only.



**Uptown™ small basin
mixer tap**
CB.SPT.19



**Uptown™ large basin
mixer tap**
CB.LPT.19



**Uptown™ deck mounted
bath filler**
CB.DBF.19



Uptown™ bath shower mixer
CB.BSMT.20

TAKE A CLOSER LOOK AT CENTRAL™

FEATURES AND DIMENSIONS

KEY FEATURES

- Rounded paddle lever
- Aqualisa branded
- LP/HP systems
- Brass body with zinc handles
- Polished chrome finish colour
- 5 year guarantee
- WRAS approved



SMALL BASIN MIXER TAP

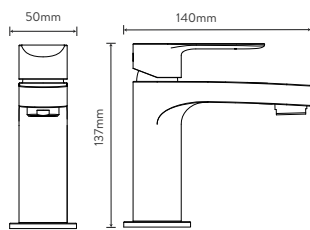

LARGE BASIN MIXER TAP

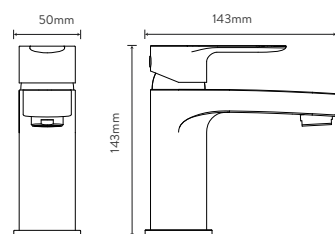

DECK MOUNTED BATH FILLER

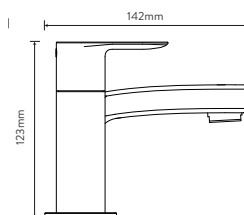
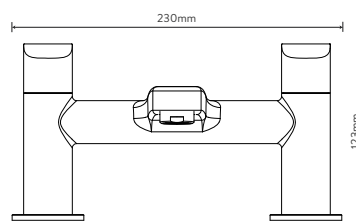

BATH SHOWER MIXER

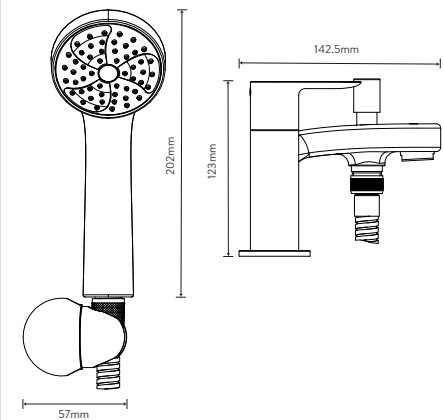
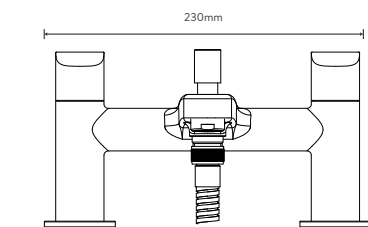

Product measurements for guidance only.



Central™ small basin mixer tap
CT.SPT.CH



Central™ large basin mixer tap
CT.LPT.CH



Central™ deck mounted bath filler
CT.DBF.CH



Central™ bath shower mixer
CT.BSMT.CH

USEFUL INFORMATION

Benefits of smart showering

Quartz™ showers combine smart technology with simple, one-touch operation.



Our SmartValve™ checks the temperature constantly, so you don't have to.

Prepare your shower with a remote control, which can be used up to 10 metres away. Excluding Quartz Blue™.



Find your perfect shower temperature, flow rate, outlet and duration. Use the app to save it and recreate your perfect shower every time.

Our intelligent Aqualisa SmartValve™ is located up to 10 metres away from the bathroom, making new and replacement installations easy to plan and tidy to fit.

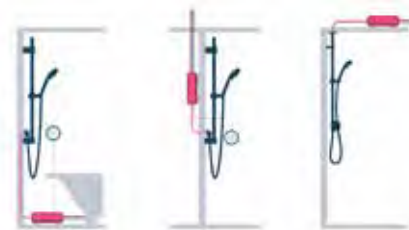

All Quartz™ Collection showers include bath fill options. Using a programmed setting, you can fill your bath to your perfect depth and temperature, from the comfort of your armchair.

“Hey Google, turn on my shower”



Wifi connectivity integrates Quartz showers into your smart home.



Start your shower or run your bath with your smart speaker.



The Aqualisa app lets you use your phone to start your shower or run your bath. You can also set personal profiles, keep track of your water usage and estimated costs.

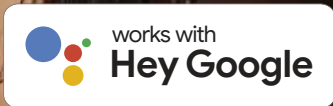
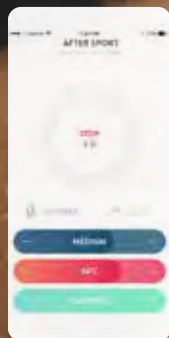
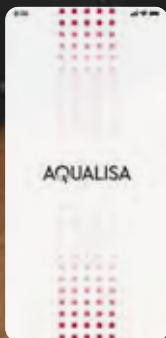

Profile dependant on model

EVERY DROP COUNTS



Builders, developers and consumers are increasingly aware of their ecological responsibilities. It's estimated that an average family can get through around 600 litres of water a day*. A lot of that takes place in the bathroom.

Thankfully, advances in technology mean we can all save water and still stay clean. Aqualisa's designers have gone to great lengths to ensure we offer eco-solutions across smart, mixer and electric showering ranges with innovative ways to help you save water without compromising your showering experience. If we all do a little, a lot can be achieved.

*Based on figures from WaterWise (www.waterwise.org.uk)



VITAL SAVINGS

All our electric showers carry the **European Water Label** and are rated Energy Efficiency 'A'



ECO SMART*

Our smart showers have a number of unique eco features, to help you do your bit for the environment.

The SmartValve™ in our Quartz™ and Visage™ showers can be set to 'eco' mode capable of reducing water flow by up to 33%, or as little as 8 litres per minute.

Our new Q™ smart shower features a clever proximity sensor, meaning that water is automatically reduced to minimum flow when you move away to shampoo, condition your hair and then returns to your original setting as you move closer.

*Feature may not operate on combination boiler systems.

DID YOU KNOW?

THE AVERAGE BATH
USES UP TO
**100 LITRES
OF WATER**

That's in comparison to a quick shower, which uses around 30 litres of water. So if you want to be greener in the bathroom, it makes sense to shower. Activating Aqualisa's smart shower 'eco features' will help too – as will using the 'eco' spray on our Harmony™ shower heads, the eco-stop button on our bar valves or using appropriate flow regulators.



CONTROL THE FLOW

Our Midas™ showers are also available with a choice of regulators that limit water flow to as little as 6 litres per minute. They save water, reduce running costs and meet existing building regulations.



IN HARMONY WITH NATURE

Ideally, we all want a powerful shower that doesn't use too much water. Shower head design is crucial in terms of both ergonomics and ecological efficiency.

Some water-saving shower heads aerate the flow of water to deliver the 'illusion' of bubbles, but we weren't prepared to compromise the way your shower looks or feels. Our Harmony™ heads use intelligent design to deliver a fuller spray whilst allowing you to make water savings of up to 25%.

When the 'eco' spray on a Harmony™ shower head is selected, the shower head concentrates and angles the spray from its two outer rings. The result is a spray pattern that is refreshing and generous yet incredibly efficient in terms of water consumption.

Harmony™ shower heads supplied with Quartz™, Visage™, Midas™ 100 and 110, Aspire™ DL, Siren™ SL, Colt™, Aquastream™ and Dream™.



'Eco' spray pattern

Outer spray pattern

up to
25%
less water

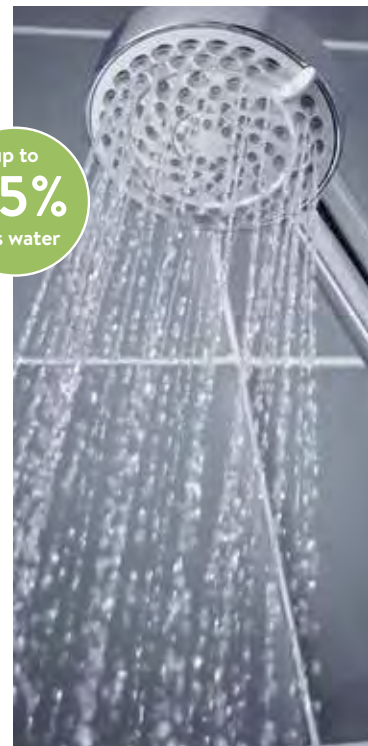

REFURBISHING AND REFITTING YOUR BATHROOM?

Refurbishing an old bathroom from scratch can be a big job, so if time and budget are limited, or you simply want to smarten up your shower, why not opt for a refit? When it comes to refurbishments, Aqualisa has long been regarded as a go-to brand by those in the know. All with good reason, because no matter the system or showering technology, there's a very good chance we'll be able to help you find the perfect solution.

CONVERT YOUR MIXER VALVE TO A SMART SHOWER WITHOUT RE-TILING

You can now update to a smart shower without having to re-tile your shower area. The Quartz Smart Retrofit Shower allows you to replace an exposed mixer shower with any choice of exposed shower from the Quartz™ Smart Collection.

The smart control docks with the attractive chrome shelf to hold the shower unit securely in place without requiring new tile work. If necessary, a rail extension to the ceiling allows the new shelf assembly to be positioned at exactly the required height to cover existing pipework connections. A unique upgrade solution as well as useful storage.



QUARTZ™ SMART RETROFIT WALL PLATE

Replacing an old built-in-shower with a Smart model is exciting. However, if you find some damage when you remove your old shower, you can easily conceal this with a Quartz™ Smart retrofit wall plate. It's perfect for disguising the cavity left by the old valve and creates a streamlined appearance.

GO SMART, MINIMISE DISRUPTION

An exposed Smart shower can be up and running in as little as a few hours. A brilliant solution for any new bathroom, but it's especially good for over baths or bathrooms where there hasn't previously been a shower.

Because the control is mounted on the shower rail which doubles up as the blended water pipe – all that needs to be done is to feed the pipework through a small hole in the ceiling, connect it to the SmartValve™ and fix the shower to the wall – no damage to existing tiles or décor. It really is that simple.

DID YOU KNOW?

A SMART SHOWER CAN SOLVE NEGATIVE HEAD

If you need to fix a shower head above the water tank base, choosing a Smart shower with a pumped SmartValve™, makes it perfect for loft conversions!



UPGRADE A BAR VALVE TO MIDAS™ SHOWER COLUMN

Changing your bar valve? Why not upgrade to a new, multitasking bar valve that offers the versatility of two shower heads? Thanks to the clever retrofit features of bar valve mixers such as Midas™ 110 and 220, installing them is a lot easier than you might think.

Midas™ 220 shower column

REPLACE AN EXPOSED SHOWER WITH AN ASPIRE™ DL OR SIREN™ SL

Replacing an older, exposed shower doesn't need to be difficult when you can use one of Aqualisa's new generation mixer showers. The exposed models of both our Aspire™ DL and Siren™ SL shower ranges feature adjustable inlet centres, ideal for refurbishment projects where a degree of flexibility is required.



EASIER ELECTRIC SHOWERING

If you need to upgrade an electric shower, look no further than Quartz™ Electric. The shower has been designed with refits in mind and has an extra roomy 'footprint' to hide all traces of the previous shower.

Your installer will also love it as the Quartz™ Electric features two positions for earth connection and will also allow you to use the previous shower's compression elbow, handy for simplifying the replacement procedure.



You have our full support

We pride ourselves on fast, friendly and efficient customer service. So, whether it's a quick question about your new shower, a technical query or if you would like to arrange a visit from one of our nationwide service engineers, simply pick up the phone, email us or visit our website for a live chat. We'll be happy to help, regardless of the age of your shower.



Contact us:

ADVICE, SUPPORT AND GENERAL ENQUIRIES:



Customer Service Helpline:
01959 560 010



Switchboard:
01959 560 000



Email:
enquiries@aqualisa.co.uk



Website:
www.aqualisa.co.uk



Live chat:
www.aqualisa.co.uk



Customer Service webpage:
www.aqualisa.co.uk/customer-support

Our telephone lines are open Monday to Friday, 8am to 5pm.
We are closed on Bank Holidays, Saturdays and Sundays.

FREE INSTALLER TRAINING

Join 1000's of installers who have benefitted from Aqualisa Installer training. For further information visit **www.aqualisa.co.uk/aqualisa-training** or call our training team on **01959 560 042**



**AQUALISA
INSTALLER
CLUB**



www.aqualisa.co.uk/installerclub

AQUALISA FREE GUARANTEE

We pride ourselves on quality workmanship, engineering innovation and excellent Customer Service. Our products are covered with a manufacturer's free 1 year guarantee which can be extended up to 5 years, unlike many other manufacturers.

When you register your shower, you can easily increase your FREE guarantee to 2, 3 or even 5 years dependent on the product. Registering your shower ensures you are covered, giving you access to our dedicated UK Customer Care team and specialist engineers.

*Please see our website for details and full Terms and Conditions.

PREMIUM SERVICE

Your shower is just as important to us as it is to you. Our UK Customer Care team, based in Westerham, Kent, are a friendly team of shower experts on hand to answer your queries. Our commitment to rapid response means they will assist you quickly and professionally when you need any help.

DEDICATED SUPPORT ENGINEERS

We offer nationwide coverage with our team of Aqualisa trained and approved service engineers. They are experienced and qualified engineers who fulfil the Aqualisa Customer Care promise, ensuring that our reputation for both quality and service is maintained at all times.

*For more information, terms and conditions, visit
<https://www.aqualisa.co.uk/register-your-guarantee>



Aqualisa products are covered by a 1-year guarantee period. Please visit our website regarding the guarantee periods available once you register your product.

All products before registration
Any products used in a non-residential environment

AQUALISA

Aqualisa Products Limited
The Flyers Way
Westerham
Kent TN16 1DE

Customer Service and Technical Helpline:
01959 560 010

Brochure request line:
0800 652 3669

Website:
www.aqualisa.co.uk

Email:
enquiries@aqualisa.co.uk



@AqualisaShowers



@AqualisaShowers



@AqualisaShowers



Aqualisa



Scan to visit
our website



The company reserves the right to alter, change or modify the product or product specifications without prior warning. Please refer to the installation guides for technical information.
Registered Trademark Aqualisa Products Limited.

Copyright © Aqualisa 2021. All rights reserved. No part of this brochure may be reproduced whether by copying or storing in any medium, electronic or otherwise, without the express permission of Aqualisa subject to any contrary provision under the Copyright, Designs and Patents Act 1988. Any unauthorised reproduction of any part of this brochure may lead to a civil claim for damages or criminal prosecution.
Errors and omissions excepted.